

Imagine the possibilities...



THE **DISPLAY FOLIO**[®]
Exhibit & Display Catalog

THE DISPLAY FOLIO®

Exhibit & Display Catalog

In the demanding environments where display products are relied on day after day, customers increasingly recognize the importance of quality and of having a partner who can support their evolving needs.

Whether you need one stock item or five thousand custom frames, we are committed to being your source for quality and value in visual merchandising.

We continue to invest to improve the quality of the products and services we deliver to you, our customers. It takes a team effort from our employees, whose priority is ensuring that your projects are successful. Our approach has always been to listen carefully to our customers, and to deliver products that meet your evolving display needs. We service a wide range of industries.

We are proud of our extraordinary reputation for quality, value and reliability. We source the finest quality components, and because we manufacture in the U.S., our supply chain is shorter, "greener", and we can offer customizable solutions tailored to your needs. We are excited about our future and look forward to continuing our pursuit of opportunities together!

A PRODUCT BOOK

This catalog strives to show exactly how our products are made and how they work. Suggestions on uses are offered using rendered images. The goal is to offer exacting details and specs. We welcome your feedback and promise quality and value.

Charisma - SEG (Silicone Edge Graphics)

Fabric Frames	4-11
Light Boxes	12-15

SignFrames

SignPost System™	16-19
Hybrid SnapFrames™	20-21
SupraSlim SnapFrames™	24-25
EasyOpen SnapFrames™	26-27
SnapFrame Stands™	28-29
Silhouette TrimFrames™	31
Perfex Frames™	32-33
Pedestal Frames™	34-35
SignsAnywhere™	36-43
Monster Frames™	44-47
Poster Pedestal SignHolders	48-56
A Frame SignHolders	57-59
Convex SignHolders™	60-62
Atlas SignHolder™	63

CounterTop

Eclipse™	64
ArcTop™	65
Miscellaneous CounterTop	66-71
Wet Erase Menu, Plastic Pocket Stands	72
Metal SignBacks	73
Framettes™	74-77

CUSTOMIZATION

Beyond the hundreds of products, configurations, layouts and options shown, this latest catalog is an Idea Book. Because we manufacture most everything in house, many products can be customized to client's specifications.

Hanging Graphic Hardware

SnapGraphics™	78-81
EasyGraphics™	82-83
Trapeze Bars™	84-87
Hanging Kits & Clamps	88-89
Ceiling Anchors, Links & Cables	90-91

Tension Fabric Structures

Straight Flat Walls	92-93
Graphic Headboards™	94-95
Cobra & Crescent Stands™	96
Mega Wave Walls™	97
Cool C Walls™	98-99
Halos & Circle Moons™	100-101
HaloRails™	102-103
Horizon Pillowcase™	104-105
Collage Pop-Ups™	106-109
Presto Pop-Ups™	110-115

Banner Stands

Mercury Retractable	116-117
Classic - Portable	118-121
Nexus SnapBar™	122-123
Harmony™	124-125
Quest - Sign™	126-127
Ultra™	128-129
GripGraphic™	130-131
Budget™, Showroom, Promo™	132-135
Large Format	136-141
Lights, Bases, Cases	142-147

FROM CONCEPT TO ROLLOUT

Our team of project managers, designers, and engineers are ready to help take your idea from sketch to fully rolled-out solution. Our flexible US factory allows us to deliver exactly what you need quickly, with full CAD and prototyping capabilities.

Rigid Graphic Stands

Mightee Mounts™	148
Curvettes™	149
Double L Mounts™	150-151
Skyscraper MighteeMounts™	152-153

Specialty Displays

iPad Stands	154-157
Aluminum Slatwall™	158-161
Pallet, Simple SignHolders	162-163
Clamp Stands	163-165
Exhibitor Stands	166-167
Privacy Stands	168-169

Easels

Hotel, Tradeshow & Facility	170-171
Flip Chart Presentation	172-174
Art Trees & Artist Easels	175-177

CHARISMA Fabric Frames™

STUNNING VISUAL IMPACT

Available one or two sided, can be made to any size.

Luxurious appearance,
affordable cost.

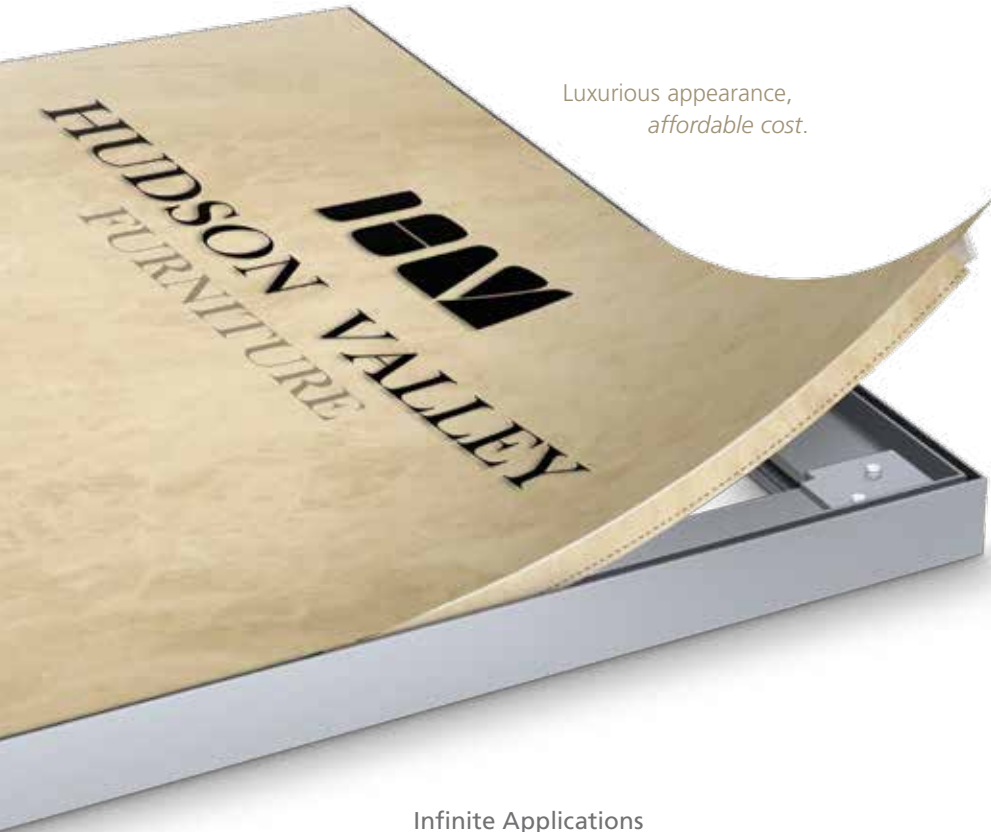

Infinite Applications

- Tradeshows, expositions & events
- Airports, bus & train terminals
- Retail store windows
- Retail interiors, P.O.S. applications
- Office, meeting, room interiors
- Space/room dividers, lobbies
- Hotels and hospitality settings
- Museum installations

SEG Silicone Edge Graphics

High resolution dye sublimated fabric graphics with a thin silicone perimeter sewn on. When fitted into the recessed groove of the Charisma aluminum frame, the result is a very attractive drum tight fit.



CHARISMA Fabric Frames™ - the *perfect* display panel.

- One that is upscale and luxurious but still cost effective
- One where graphic changes are fast and easy
- One with texture that is non-reflective and sound absorbing
- One that is frameless with no visible sew lines
- One that packs, ships and distributes in a tube, yet can fill a wall
- One with the lowest shipping cost per square foot of graphic
- One that provides not just graphics, but great ambiance

Dye Sublimated Printing

Dye Sub Printing on fabric offers a richness and intensity of both color & texture. When assembled to our frames, the result is magnificent.



COMMERCIAL - RETAIL - TRADESHOWS AND EVENTS

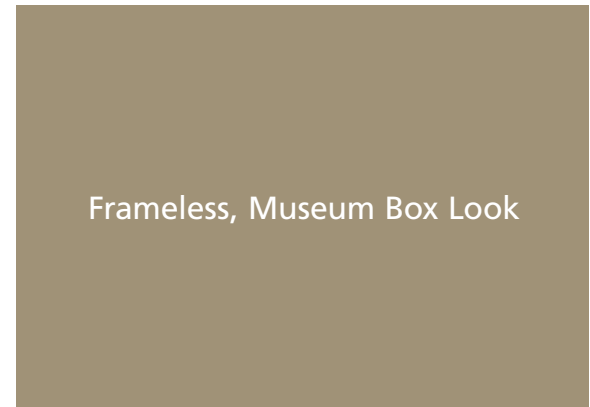

CHARISMA Fabric Frames™

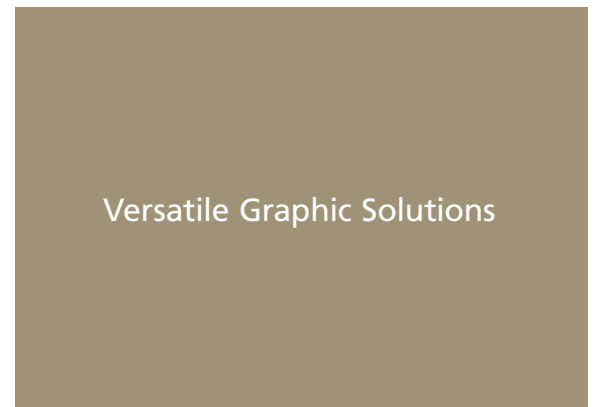



Graphic Wall Room Dividers



Commercial, Corporate, and Trade Show Environments

CHARISMA Fabric Frame

MOUNTING OPTIONS: Wall Mount, Ceiling Hung, or Free Standing.



STRONG, STEEL CORNER BRACKETS



Floor Models with Marquis or Round Bases.

SINGLE SIDED

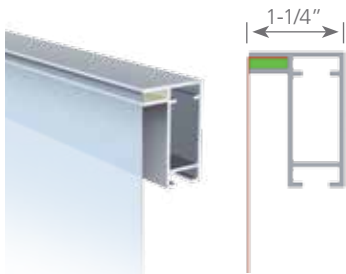

DOUBLE SIDED

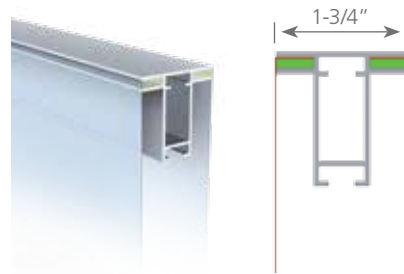

The Silicone strip (green) gets stitched to the graphic perimeter (red) and inserted into the channel for a drum tight fit. To ensure strength & stability, the wall thicknesses of our profiles are particularly substantial.

DISTORTION CONTROL BRACKET



These brackets may reduce or eliminate the need for spanner support bars. Good only for single sided Charisma wall mount frames.
XSDCB

SPANNER SUPPORT BARS

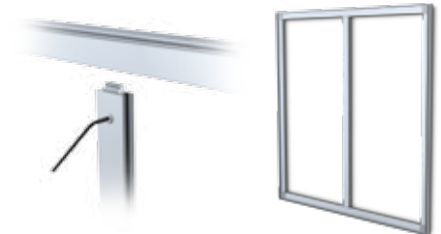

Spans greater than 48" require Spanner Support Bars, unless they are wall mounted. Quick connect hardware included on each end.

Standard Sizes

Specify: Frame Kit –Mounting

FRAMES CAN BE MADE TO ANY SIZE

Please contact us for prompt quotation.

Single Sided	Double Sided	Size	Single Sided	Double Sided	Size
XSM23A	XSM23B	24" x 36"	XSM56A	XSM56B	60" x 72"
XSM24A	XSM24B	24" x 48"	XSM58A	XSM58B	60" x 96"
XSM34A	XSM34B	36" x 48"	XSM66A	XSM66B	72" x 72"
XSM35A	XSM35B	36" x 60"	XSM68A	XSM68B	72" x 96"
XSM36A	XSM36B	36" x 72"	XSM610A	XSM610B	72" x 120"
XSM45A	XSM45B	48" x 60"	XSM88A	XSM88B	96" x 96"
XSM46A	XSM46B	48" x 72"	XSM810A	XSM810B	96" x 120"
XSM48A	XSM48B	48" x 96"	XSM1010A	XSM1010B	120" x 120"

Wall or Ceiling Mount*

- WM Wall Mount
- CP Ceiling Vertical
- CL Ceiling Horizontal

*Does not affect price

Floor Mount*

- FPMB Floor Vertical, Marquis Base
- FLMB Floor Horizontal, Marquis Base
- FPRD Floor Vertical, Round Base
- FLRD Floor Horizontal, Round Base

*Does not affect price

Spanner Support Bars

XSB2	24"
XSB3	36"
XSB4	48"
XSB5	60"
XSB6	72"
XSB8	96"
XSB10	120"

LINKING CONNECTORS



For long custom frames, in-line linking connectors are required. Offered on a project basis.

PANEL ASSEMBLIES

Side by side continuous walls, tees, angles & other structural configurations are offered on a project basis.

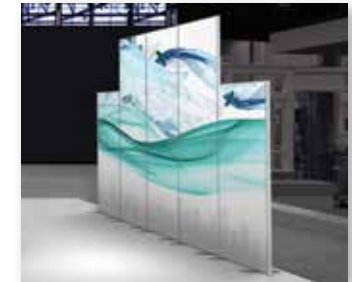
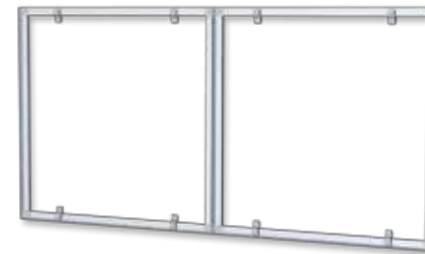

Side by side walls have drilled holes & simple screws & nuts.

FLOOR MODEL BASE OPTIONS

Bases attach to frame with elastic stop nut.



Marquise bases,
18" x 8.75"

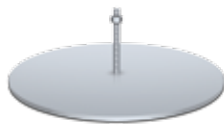

11" Round bases.
Use when only a small
base is best.



Brackets are
heavy gauge steel.



ACCESSORIES



Silicone strips, 1/8" thick, not included with frame kits, Sold separately.
300' rolls -**XSSL300**

Accessories

XSSL300	300' roll of silicone strip
XSQK-0	24" x 24" sample frame only
XSQK-1	24" x 24" sample frame with graphic



For tee's, angles, etc., we typically use heavy gauge steel brackets with simple connecting hardware.

CHARISMA MINI Fabric Frames™



Slim profile SEG Frames for Wall Mounting

- Tradeshows, expositions & events
- Airports, bus & train terminals
- Retail interiors, P.O.S. applications
- Office, meeting, room interiors
- Hotels and hospitality settings
- Museum installations

Slim lightweight frame, just 9/16" in depth.



Wall hangers provided. Mount horizontally or vertically.

The Silicone strip (green) gets stitched to the graphic perimeter (red) and inserted into the channel for a drum tight fit.

FRAMES SIZES CAN BE CUSTOMIZED
Please contact our friendly sales staff for prompt quotation.

Slim profile SEG Frames for Wall Mounting

- Smaller frame sizes for greater range of applications
- Graphic changes are fast and easy
- Frameless graphics with no visible sew lines
- Wall hangers provided
- Super sharp price points
- Fabric graphics provide luxurious look and feel
- Provides not just graphics, but great ambiance
- Handsome Satin silver finish

XMIN4	14" x 22"
XMIN5	18" x 24"
XMIN6	22" x 28"

XMIN7	24" x 36"
XMIN8	30" x 40"
XMIN9	36" x 48"



CHARISMA Picture Frames™

CLASSIC & FUNCTIONAL

wall mounts vertically or horizontally

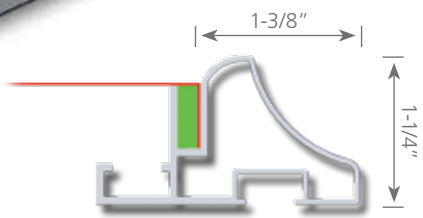
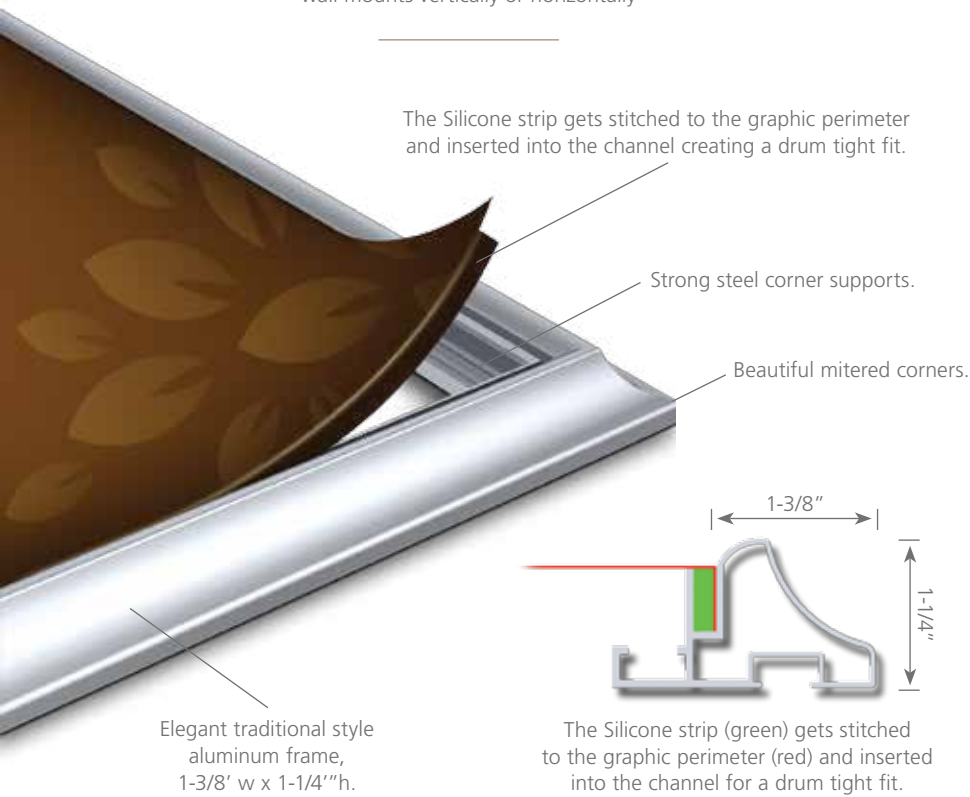

The Silicone strip (green) gets stitched to the graphic perimeter (red) and inserted into the channel for a drum tight fit.

CUSTOM COLOR

Requests encouraged!



ELEGANT SEG PICTURE FRAME.

- Traditional Style Frames accept SEG graphics
- Graphic changes are fast and easy
- Great for Retail/Home/Office
- Wall hangers provided
- Super sharp price points
- Fabric graphics provide luxurious look and feel
- Provides not just graphics, but great ambiance
- Choose Satin Silver or Matte Black Finish

CUSTOM SIZES AVAILABLE!

XSP4	14" x 22"	XSP7	24" x 36"
XSP5	18" x 24"	XSP8	30" x 40"
XSP6	22" x 28"	XSP9	36" x 48"

Color: -S Satin Silver -B Matte Black



CHARISMA SEG/LED Light Boxes™

Add Ambiance for your Signage

with bright, efficient LED lighting that brings out vivid colors and textures enhancing all environments.

STUNNING VISUAL IMPACT

Available one or two sided, can be made to any size.

Featuring:

- Evenly distributed LED lighting
- Extremely easy to assemble/install
- Wall mount, ceiling hung or free-standing options
- Frameless, edge to edge display



Great for:

- Retail Interiors & Windows
- Brands
- Facilities
- Showrooms
- Offices
- Tradeshows & Events
- Room Dividers

The Best of all Worlds

Low installation costs,
Low shipping costs.

Low energy costs,
Extremely eye-catching.

Dye Sublimated Printing

Dye Sub Printing on fabric offers a richness and intensity of both color & texture. When assembled to our frames, the result is magnificent.



CHARISMA SEG/LED Light Boxes™

LED Perimeter Lights

- Ultralong 50,000 hour life
- Very low energy consumption
- Cool, virtually no heat
- Bright efficient illumination



Light strips daisy chain to each other. Assembly & installation is ultra easy.

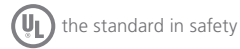

Profile Cross Section

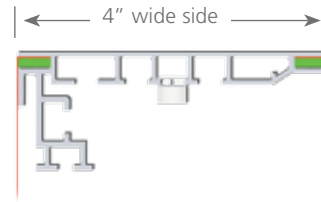

The Silicone strip (green) gets stitched to the graphic perimeter (red) and inserted into the channel for a drum tight fit.

Graphic change outs are extraordinarily fast & easy.



Attractive strong aluminum alloy case in an etched and satin anodized finish.



CHARISMA SEG/LED Light Boxes™

Packaging

Our Charisma SEG/LED Light Boxes come disassembled, components packed in a compact corrugated carton, making for easy transport, storage and lower shipping costs. Assembly on site is fast and easy. Hard cases are also available.



Assembly



1. Insert corner brackets into slots.



2. Tighten screws to lock corners.



3. Daisy chain light strips together.



4. Install graphic onto frame.

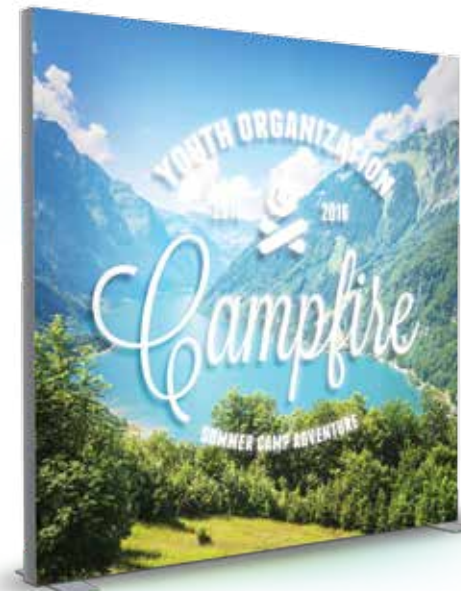

CHARISMA SEG/LED Light Boxes™

Wall Mount - Hanging - Free-Standing

Unless otherwise noted, Charisma LED Light Boxes are supplied with heavy Wall Mount Zee brackets.

Forged Eyebolts can be substituted at time of order for the Zee brackets at no additional charge - indicate orientation.

For Free-Standing Floor models, Charisma Boxes and accessory Base Sets must be ordered together.

Pricing Examples

Charisma SEG/LED Light Boxes are made to order. Most of the time size requirements are custom.

The following sizes are offered on our price sheets to serve as an indication of what custom sizes will cost.

Please contact our friendly sales department for exact pricing for specific size boxes.



XBX34	36" x 48"	XBX58	60" x 96"
XBX46	48" x 72"	XBX69	72" x 108"
XBX48	48" x 96"	XBX810	96" x 120"

XBXLS Accessory Base Set

Specify Orientation: **-V** Vertical **-H** Horizontal



SignPost à la Carte™

Sign Post à la Carte Ordering

Design a custom solution using multiple frames, banner rods, graphic clips and literature holders. Also, many of our CREO accessories can be accommodated to this system. Our friendly sales staff is ready to help!

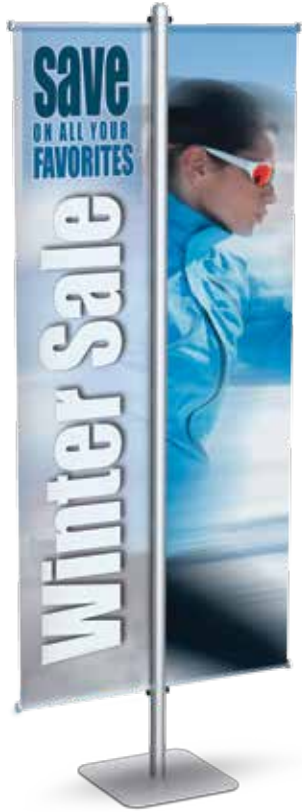

Uprights

Aluminum alloy, slotted 2 sides. Architectural cap.

YU6	72"
YU8	96"

-S Silver -B Black



Laser Cut Bases

Matte texture finish.



YBQ	16" Square	17 lbs.
YBR	17" Round	16 lbs.

-S Silver -B Black

Drop In Perfex Frames

Graphic sizes:

YPX5	22" x 28"
YPX6	24" x 36"
YPX9	22" x 56"

-S Silver -B Black



SnapFrames

Front load, includes matte lens & back.

YE07	22" x 28"
YE09	24" x 36"
YE56	22" x 56"

-S Silver -B Black



Special order with clear lens.

Graphic Rods

Sleek, moveable 5/8" diameter tubes. Aluminum face-out puck for hemmed graphics. 2/set.

CRGR-1	18"
CRGR-2	24"

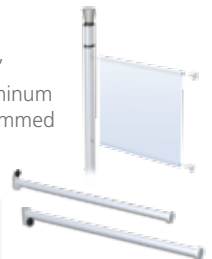

Design the stand best suited to your client's display opportunity!



Panel Grippers
Frameless graphic attachment of rigid substrates.



- Specify thickness:
- CRPG1** .020" - .125"
 - CRPG2** .125" - .250"

CRPG interlocking, 2 pairs per.

Graphic Clips
Snaps on, holds semi-rigid and rigid graphics up to 1/8" thick. Strong economical option.



HT3 Set of 2

Literature Holders
Steel powder coated. Can use 2 back to back, center hung.



- YLTP1** - Pamphlet (4)
 - YLTC1** - Catalog (2)
- S Silver -B Black

Literature Holders
Steel powder coated. Can use a left and a right, side by side. 9" x 11-3/4".



- CRLSLM** left mount
 - CRLSRM** right mount
- S Silver -B Black

SignPost Frame Kits™

Frame/Stand Kits

These complete SignPost outfits include a laser cut weighted steel base with a durable matte finish, an aluminum 72" upright slotted on two sides for height adjustments, and a choice of two aluminum frame styles: drop-in or front snap-open. Sold as complete sets, many of our À la Carte & Creo accessories can be added. Our sales staff is ready to help!



Y1SN2CHR-D-S



Y1SN2CHR-D-S
with YLTC1-S



Y2SN2CHSQ-S



Y2PD9CHR-D-S



Y2PD2CHSQ-S
with (2) YLTP1-S



Y2SN2CHR-D-S
with (4) YLTC1-S

Kit Ordering:

# of Frames	Frame Type	Graphic Size	Frame Position*	Base*	Color*	
Y1 One Frame	SN SnapFrame	2 22" x 28"	CH Center Hung	SQ Square	-S Satin Silver	*Does not affect price
Y2 Two Frames	PD Perfex Drop In	4 24" x 36"	OF Offset	RD Round	-B Matte Black	
		9 22" x 56"				

Beautifully Designed, Extraordinary Stability!



Y1PD4CHSQ-S



Y2PD4CHSQ-S
with (2) YLTP1-S



Y1PD4OF
with (3) CRLSRM-S



Y1PD9OFRD-S



Y2SN2OFRD-S
with (2) YLTC1-S

Drop In Perfix Frames
Viewable 2 sides,
3/16" full top entry slot.
Mounting hardware
included. Center or
offset hung.



SnapFrames
Front load, matte lens &
styrene back. For posters
and paper signs up to
1/32" thick. Special order
with clear lens. Center or
offset hung.



Literature Holders
Steel, can use 2 back
to back. Center hung.

- YLTP1 - Pamphlet (4)
- YLTC1 - Catalog (2)

-S Silver -B Black



Literature Holders
Steel powder coated. Can be used
side by side. 9" x 11-3/4".

- CRLSLM left mount
- CRLSRM right mount

-S Silver -B Black



Hybrid SnapFrames™



HE7-S

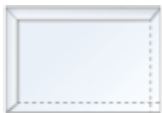

3/8" margin.

CHANGE
GRAPHICS
EFFORTLESSLY

HYBRID SNAPFRAMES

Aluminum covers atop plastic SnapFrames - 1-1/4" wide, no springs.

Features:

- Aluminum Covers
- Plastic SnapFrame
- No metal springs
- Matte or clear lens
- Satin silver or matte black finish
- Precision mitered corners
- White plastic corrugated backer
- Wall anchors & mounting screws
- Accepts substrates to 1/32" thick

Specify: Model – Color* – Lens*

Model	Graphic Size	Model	Graphic Size
HE7	22" x 28"	HE10	30" x 40"
HE9	24" x 36"	HE11	36" x 48"

Color*

-S	Satin Silver
-B	Matte Black

Lens*

-C	Clear Lens
-M	Matte Lens

*Does not affect price.



Choice!

Hybrid SnapFrames
come with a choice of:
-**C** Clear or -**M** Matte lenses.

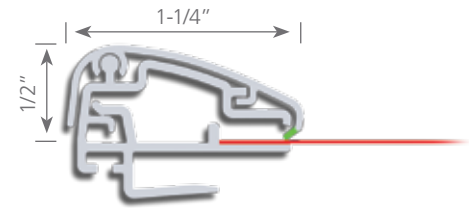

Beautifully mitered corners.

Holes for horizontal
or vertical wall mounting.

Aluminum
frame cover.

Plastic SnapFrame
- no springs.

Satin silver or
matte black finish.

Plastic corrugated backing.

Choice of matte or clear lens.

FANTASTIC NEW DESIGN HOLDS GRAPHICS SECURELY

HYBRID SNAPFRAMES

Aluminum covers atop plastic SnapFrames - no springs.



Custom sizes available.



Double sided, back to back versions available - call our friendly sales staff.
Perfect for windows and mid store positions.

CHANGE GRAPHICS EFFORTLESSLY
FOR SEASONAL PROMOTIONS.

Plasti SnapFrames™

ATTRACTIVE STRONG & EXTREMELY COST EFFECTIVE



Front Loading Plasti SnapFrames

- PVC frame, 1-1/8" wide, 5/8" deep
- Accepts posters to 1/32" thick
- Vertical & horizontal mounting holes
- Plastic corrugated backer
- One piece "living hinge" construction
- Wall screws and anchors included

Specify: Model - Color* - Lens type if applicable*

Frame No	Lens	with/Lens*	Graphic Size
PE1	PE1L		8" x 10"
PE2	PE2L		8-1/2" x 11"
PE3	PE3L		11" x 14"
PE3.5	PE3.5L		11" x 17"
PE4	PE4L		14" x 22"
PE5	PE5L		16" x 20"
PE6	PE6L		20" x 24"
PE7	PE7L		22" x 28"
PE8	PE8L		24" x 30"
PE9	PE9L		24" x 36"
PE10	PE10L		30" x 40"
PE11	PE11L		36" x 48"

Color*

- S Satin Silver
- B Matte Black

Black is NOT recommended in direct sunlight.

For those models with lenses* indicate

- C Clear
- M Matte

*Does not affect price.

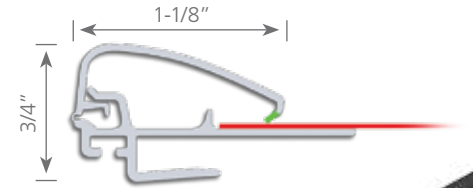

Beautifully mitered corners.

Holes for horizontal or vertical wall mounting.

Co-extruded SnapFrames - no springs

Strong PVC frame.

Plastic corrugated backing.



3/8" margin.

CHANGE GRAPHICS EFFORTLESSLY!

EASY-OPEN SNAPFRAME DIVIDERS



Bars are permanently positioned wherever the client wants.

Good for ME (mitered), EO (radiused corners) & Plasti SnapFrames.

Quotes provided on a project basis, contact our friendly sales staff with a sketch of what you'd like quoted.

Not available for SupraSlim™ models.

Color Choices:

- S Satin Silver
- B Matte Black

Graphic changes are effortless, and the satin aluminum finishes are aesthetically beautiful.

Satin anodized aluminum Divider Bars work with our Plasti & Easy-Open SnapFrames™ - both mitered & radius cornered models. Not available for SupraSlim™ models.



FRONT LOADING CONVENIENCE.

IT'S A SNAP!
SO EASY!

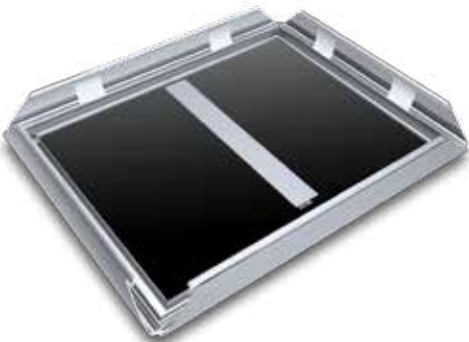

Divider Bars attach with pressure sensitive adhesive to the styrene backer.

SupraSlim SnapFrames™



Two units shown side by side.

FRONT LOADING CONVENIENCE

Features:

- Aluminum rails, 3/4" wide, 1/2" deep
- Accepts substrates up to 1/32" thick
- Matte or clear lens included
- Styrene backing included
- Mounts vertically or horizontally
- Wall hangers provided

Choice of matte or clear lens included.

Strong spring loaded.

Styrene backing.



Live area:
3/8" margin.

CHANGE GRAPHICS EFFORTLESSLY



Mitered Corners

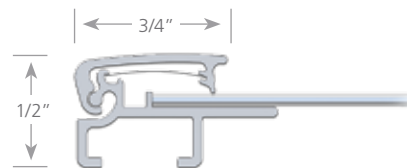

SupraSlim Profile



Matte Anodized Finishes

GREAT FOR ARCHITECTURAL APPLICATIONS



Super slim profile focuses attention on the message.

Choice!

SupraSlim SnapFrames come with a choice of:
-**C** Clear or -**M** Matte lenses.

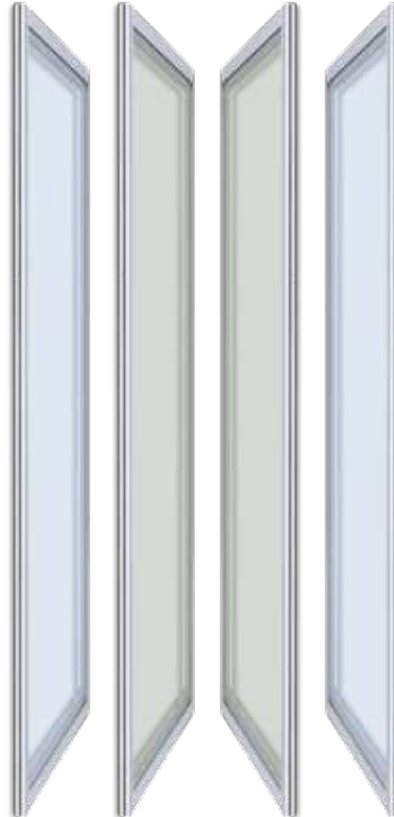

3/4" WIDE
1/2" DEEP

SHIPS FULLY
ASSEMBLED



Mount vertically or horizontally,
wall mount hardware included.



Specify: Model-Color-Lens*

Model	Size
SUP01	8" x 10"
SUP02	8-1/2" x 11"
SUP03	11" x 14"
SUP3.5	11" x 17"
SUP04	14" x 22"

Color
- S Satin Silver
- B Matte Black

Silver costs less than black.

Lens*
- C Clear
- M Matte

*Does not affect price.

Model	Size
SUP05	16" x 20"
SUP06	20" x 24"
SUP07	22" x 28"
SUP08	24" x 30"
SUP09	24" x 36"

EasyOpen SnapFrames™

CHANGE GRAPHICS EFFORTLESSLY

Features:

- Aluminum frames, 1-1/4" wide, 9/16" deep
- Accepts posters and paper signs to 1/32" thick
- Vertical & horizontal mounting holes
- Styrene backing
- Clear or matte overlay lens
- Wall screws and anchors

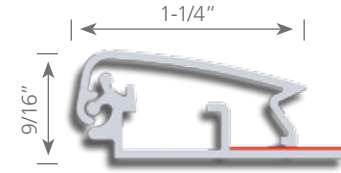

Choice!

ME & EO SnapFrames now come with a choice of:
-C Clear or **-M** Matte lenses.

- Styrene backing
- Clear or matte overlay lens
- Wall screws and anchors

Spring loaded sides for easy insertion.

Slots for horizontal or vertical wall mounting.

Beautiful mitered corners.

Lightweight aluminum frame available in satin silver, or matte black.

Clear or matte overlay lens included atop a styrene backing.

Specify: Model-Color-Lens*

Mitered	Graphic Size	Mitered	Graphic Size
ME1	8" x 10"	ME6	20" x 24"
ME2	8-1/2" x 11"	ME7	22" x 28"
ME3	11" x 14"	ME8	24" x 30"
ME3.5	11" x 17"	ME9	24" x 36"
ME4	14" x 22"	ME10	30" x 40"
ME5	16" x 20"	ME11	36" x 48"



3/8" margin.

Color: **-S** Satin Silver **-B** Matte Black

Silver costs less than black. Lens* **-M** Matte Lens **-C** Clear Lens *Does not affect price.

RADIUS CORNER SNAPFRAMES

AESTHETICALLY BEAUTIFUL

- Aluminum frames, 1-1/4" wide, 9/16" deep
- Accepts substrates up to 1/8" thick
- Semi-rigid plastic backing
- Clear or matte overlay lens included
- Vertical or horizontal mounting slots
- Four wall screws and anchors

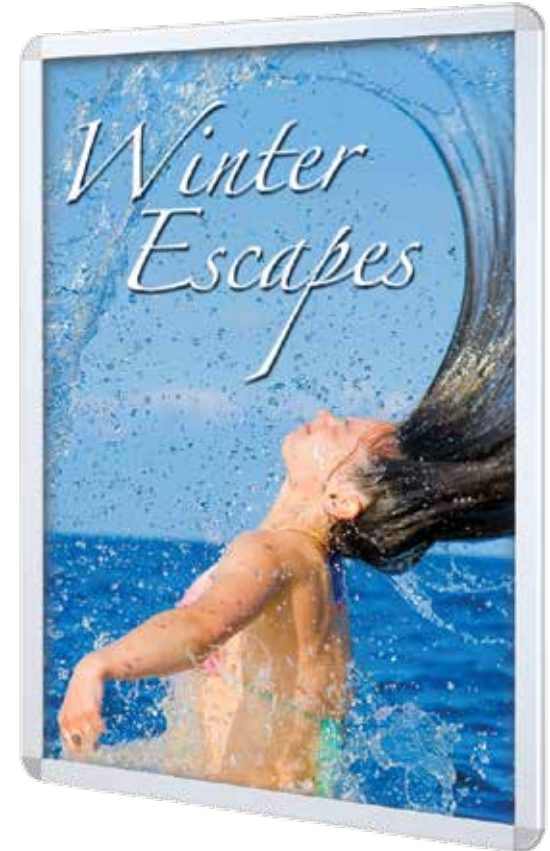

Specify: Model-Color-Lens*

Mitered	Graphic Size	Mitered	Graphic Size
EO1	8" x 10"	EO6	20" x 24"
EO2	8-1/2" x 11"	EO7	22" x 28"
EO3	11" x 14"	EO8	24" x 30"
EO3.5	11" x 17"	EO9	24" x 36"
EO4	14" x 22"	EO10	30" x 40"
EO5	16" x 20"	EO11	36" x 48"

Color

-S Satin Silver **-B** Matte Black

Silver costs less than black.

Lens*

-C Clear **-M** Matte *Does not affect price.

Radius SnapFrames accept substrates up to 1/8" thick, whereas our mitered units accept substrates only up to 1/32" thick.

Also Available:

Double-Sided

Special order frames are available. Please indicate vertical or horizontal so we know where to put the hangers.

Bulk Components

SnapFrame extrusions are available in long lengths with components bulk packed.



3/8" margin covered on all sides.

Beautiful molded radius corners.

EasyOpen SnapFrames™

EasyOpen SnapFrame Pedestal Stands

Stylish and elegant. Use for menus and other displays. Perfect for public lobbies, restaurants, retail & tradeshows.

- Easy-Open™ SnapFrames
- All metal construction
- Styrene backs
- Matte lens included
- Accepts graphics to 1/32" thick
- Sturdy, quick graphic/signage change-outs



Featuring heavy 14" x 12" steel bases, racetrack oval 37" aluminum uprights, horizontal orientation.

Featuring round laser cut bases and 36" high upright aluminum poles.

Aluminum front open SnapFrames, Laser cut round 3/16" steel bases.

Model	Size	Color*
ETD1	17" x 11"	-S Satin Silver
ETD2	22" x 14"	-B Matte Black

Special order clear lens.

*Doesn't affect price.

Model	Size	Pole	Base
ETO	8.5" x 11"	36" Straight	11" Round
ET3	11" x 14"	36" Straight	11" Round
ET1	11" x 17"	36" Straight	15" Round
ET2	14" x 22"	36" Straight	15" Round

Specify Orientation*:

H	Horizontal
V	Vertical

Special order clear lens.

Color*:

-S	Satin Silver
-B	Matte Black

*Doesn't affect price.

Angled EasyOpen SnapFrame Pedestal Stands

Perfect for public lobbies, restaurants, retail & tradeshows.

- Oval laser cut bases
- Aluminum SnapFrames
- 43" high curved uprights
- Matte overlay lens included

Poster Size EasyOpen SnapFrames

Strong, built to last.

- Aluminum 1-1/4" wide SnapFrames
- EasyOpen convenience. 66" total height
- Accepts graphics up to 1/32" thick
- Matte overlay lens, floor levelers



EF4EOH-B with PB1C lit. basket.

EF3EOV-S



Elegant aluminum racetrack oval uprights.

No bottom crossbar on double sided units.

LF5EO1-B

LF5EO2-S

Specify: Model —Orientation*—Color*

Specify: Model —Color*

Model	Size	Pole	Base
EF1EO	8.5" x 11"	43" Curved	Oval
EF3EO	11" x 14"	43" Curved	Oval
EF4EO	11" x 17"	43" Curved	Oval

Orientation*:	
H	Horizontal
V	Vertical

Special order clear lens.

Color*:	
-S	Satin Silver
-B	Matte Black

*Doesn't affect price.

Model	Size	Style
LF5EO1	22" x 28"	One-Sided
LF6EO1	24" x 36"	One-Sided

Special order clear lens/es.

Model	Size	Style
LF5EO2	22" x 28"	Double-Sided
LF6EO2	24" x 36"	Double-Sided

FrameGraphix SnapFrames™

CHANGE
GRAPHICS
EFFORTLESSLY



GREAT DISPLAY OPTIONS



Also available 2 sided.

Accepts graphics up to 50 mil.
Opaque styrene backing included.

ORDERING :

Specify: Model—Mounting*—Orientation*—Color*

Model	Size	Mounting*	Color*
XE1422	14" x 22"	CN Ceiling Hung	-S Satin Silver
XE1824	18" x 24"	WM Wall Mount	-B Matte Black
XE2228	22" x 28"		
XE2430	24" x 30"		
XE2436	24" x 36"		
XE3648	36" x 48"		

Orientation*

H Horizontal
V Vertical

* Does not affect price.
Custom sizes quoted on request.

Front snaps open for
easy graphic insertion.

Opaque styrene
back is included.

1-3/4"
overall
closed
height.

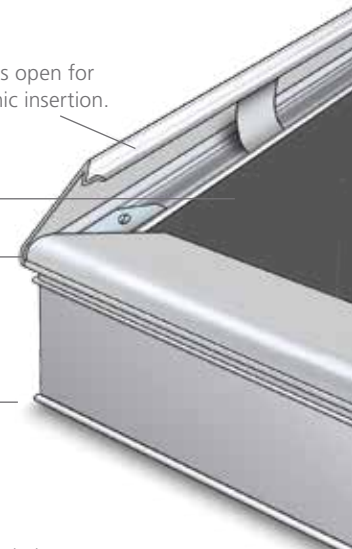

3/8" margin is
covered by frame.



Beautifully mitered corners, aluminum alloy frame, satin silver or matte black finish.

Above frames are all 1 sided. 2 sided frames available.

Silhouette Aluminum Trim Frames

Silhouette Aluminum Trim Frames feature ultra low price points.

- Super lightweight
- Extremely economical
- Real aluminum alloy
- Satin silver or matte black
- Adhesive backed
- Mitered corners
- Can be cut to any size
- Great as frame trim
- 3/32" max. media thickness



Incredibly just 1/4" slim, incredibly economical.

Use for Wall Mount applications.



CUSTOM SIZES ARE OUR SPECIALTY!

Specify: Model — Color*

Model	Graphic Size	Model	Graphic Size
OU1	8-1/2" x 11"	OU4	14" x 22"
OU2	11" x 14"	OU5	22" x 28"
OU3	11" x 17"	OU6	24" x 36"

*Color: -S Satin Silver -B Matte Black * Does not affect price.

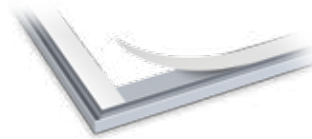

Removable adhesive backing.



Live area: 1/8" margin covered by the frame.

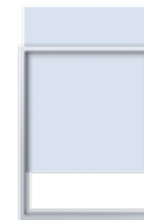

Graphic entry on short side.

Units ship completely assembled, individually bagged, bulk packed.

RETAIL



CORPORATE



HOME



HOSPITALITY

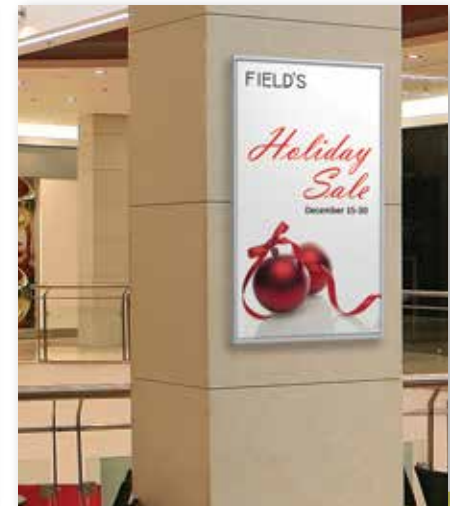

Perflex Hanging Frames™



SOLD AS A KIT

includes:
2 universal hanging clips
and
2 top & bottom wall hangers.

Other hanging hardware options available.

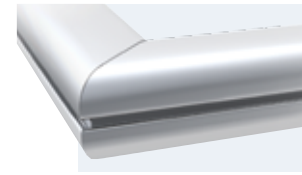

Curvilinear Satin Silver



Rectilinear Matte Black

Frames are 1" wide x 5/8" deep.

Specify: Model–Style*–Orientation*–Color*

Model	Graphic Size
PX1	8-1/2" x 11"
PX2	11" x 14"
PX3	11" x 17"
PX4	14" x 22"
PX5	22" x 28"
PX6	24" x 36"

Orientation*

H	Horizontal
V	Vertical

Color*

-S	Satin Silver
-B	Black Matte

Style*

CV	Curvilinear
RE	Rectilinear

*Doesn't affect price,
but must use to order.

Units come fully assembled, 1 per carton.



Image area:
3/8" margin covered by frame.

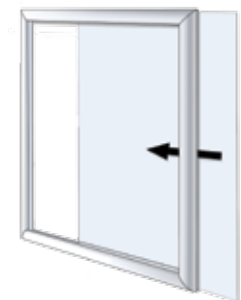

On large rollouts, packing each into a polybag & bulk can save significantly. Price on request.

Side loading. 3/16" full open slot.
Accepts 3/16" graphic and (2)
CPL 1/32" lenses (see next pg.).

Perfex Hanging Frames™

Plastic lenses Sold in pairs.

Clear	Matte	Size
CPL3	CPM3	8-1/2" x 11"
CPL4	CPM4	11" x 14"
CPL5	CPM5	11" x 17"
CPL6	CPM6	14" x 22"
CPL7	CPM7	22" x 28"
CPL8	CPM8	24" x 36"



Coroplast® Backs

White, 4 mm corrugated plastic boards make excellent frame backs. Sold individually.

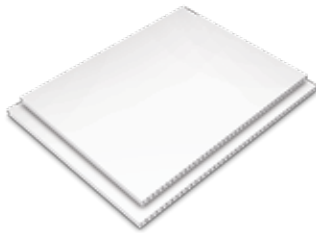

COR3	8-1/2" x 11"
COR4	11" x 14"
COR5	11" x 17"
COR6	14" x 22"
COR7	22" x 28"
COR8	24" x 36"



Dividers



Matching anodized dividers now available. Contact sales for details.

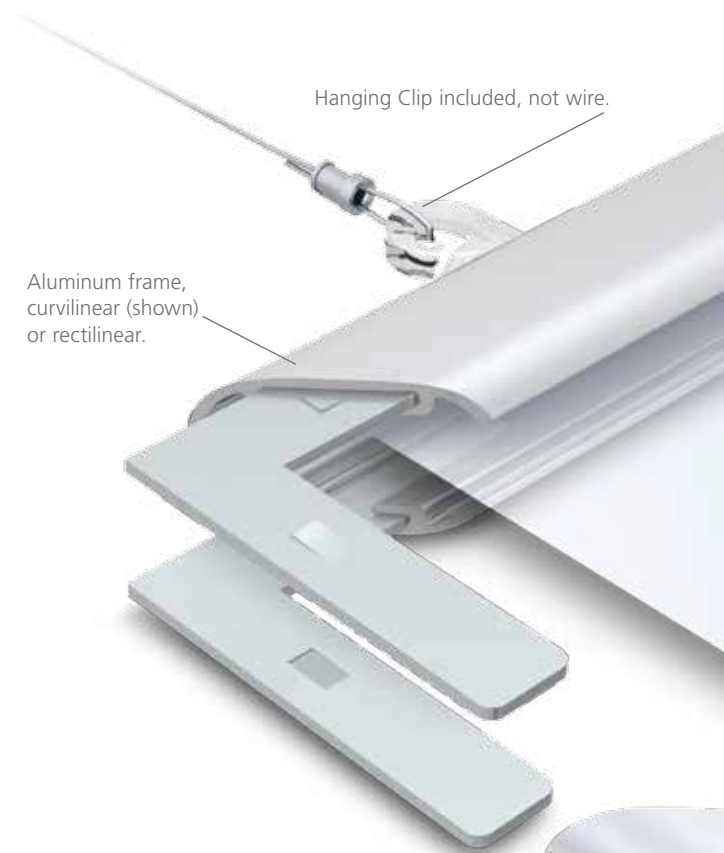

Hanging Clip included, not wire.

Aluminum frame, curvilinear (shown) or rectilinear.

Precision mitered corners.

Satin silver or matte black finish.

Accessories:

Hang frames in series using Universal Clips & Double C Hooks. (Hardware pg. 90).

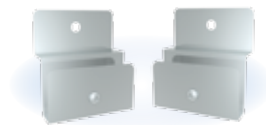
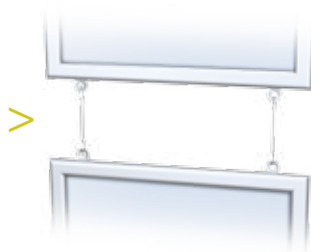

UCSW
Slatwall Kit includes 2 steel braces.

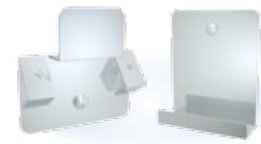

UCWM
Wall Mount Kit, includes 2 top & 2 bottom hangers.

Perfex Pedestal SignFrames™

CURVILINEAR, ALL METAL

- Heavy duty extruded alloy
- Frames have top entry slot
- Accepts graphics to 3/16" thick
- All frames are open 2 sides

CONTEMPORARY DESIGN



Top loading, accepts media to 3/16" thick.

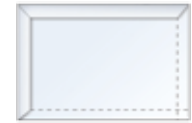

Image area:
3/8" margin is covered by the frame.
Frame is 1" wide x 5/8" deep.

Specify: Size, Base, Upright, Orientation*, Color*

Size

SF3S	8-1/2" x 11"
SF4S	11" x 14"
SF5S	11" x 17"
SF6S	14" x 22"

Base

SQ Square steel	12" sq. 5lb. SF3, 4, 5	16" sq. 9lb. SF6
RD Round discs	11" 5lb. SF3, 4, 5	13" 7lb. SF6

Upright

TP	Telescopic 26"-50"
X	Fixed 36"

Orientation*

H	Horizontal
V	Vertical

Color*

-S	Satin Silver
-B	Matte Black

*Doesn't affect price, but must use to order.

Handsome combination of Curvilinear design and precision mitering.



Curvilinear Satin Silver

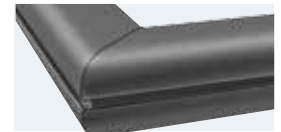

Curvilinear Matte Black



SF5SRDTPV-B



SF3SRDTPH-S



SF4SSQXH-B with PB1C Pamphlet Holder

ECLIPSE CONCAVE PEDESTALS™

Elegantly stylish design.
Choose curved back or straight back.

Use standard paper sizes.

Features:

- Metal construction
- Non-glare overlay
- 9" x 14" oval bases
- Standard pole length is 43"
- Satin finishes
- Handsome support rails
- Felt bottoms

Specify: Size -Back* -Orientation* -Color*

Size

EF1	8-1/2" x 11"
EF3	11" x 14"
EF4	11" x 17"

Orientation*

H	Horizontal
V	Vertical

Graphic Back*

CV	Curved
F	Flat

Color*

-S	Satin Silver
-B	Matte Black

*Not on price sheet, must use to order.

Non - glare overlay provided.



EF3CVH-S
Shown with **PB2C**



EF4CVV-B



EF3CVV-S
Shown with **PB1C**



EF4FH-B

Pamphlet Catalog Holders

PB1C	4" w x 2" d
PB2C	9" w x 2" d



PB1C



PB2C

These fit on all stands this page.

Signs Anywhere™



Ceiling Anchor

Strong steel clip attaches easily to grid ceilings, 6" riser. Side entry.

PX1A	8-1/2" x 11"
PX2A	11" x 14"
PX3A	11" x 17"

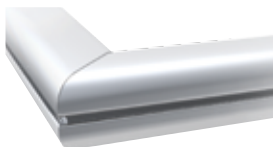

Curvilinear Satin Silver



Magnetic Mount

3-1/4" Round magnetic base for gondola tops, posts & other steel surfaces. 6" riser. Side entry.

PX1M	8-1/2" x 11"
PX2M	11" x 14"
PX3M	11" x 17"



Curvilinear Matte Black



Flange

3-1/4" round steel flange screws to wall or ceiling. 6" riser. Side entry.

PX1F	8-1/2" x 11"
PX2F	11" x 14"
PX3F	11" x 17"

All frames this page accept graphics up to 3/16" thick.

Specify:

Model — Orientation* — Color*

Orientation*	Color*
H Horizontal	-S Satin Silver
V Vertical	-B Matte Black

*Doesn't affect price.

CUSTOM MODELS AVAILABLE

Clamp-On

Metal clamp, VEE Clamp design, suitable for round tubes from 7/8" to 1-3/4" and flat surfaces from 5/8" to 2-1/2". 4" riser. Top entry slot.

PX1G	8-1/2" x 11"
PX2G	11" x 14"
PX3G	11" x 17"

Custom clamps available.

Table Top

Weighted 6-3/4" round base, felt feet, 4" riser. Top entry slot.

PX1T	8-1/2" x 11"
PX2T	11" x 14"
PX3T	11" x 17"



Magnetic Mount

Double magnetic base perfect for gondola tops, and other steel surfaces.



PX1D	8-1/2" x 11"
PX2D	11" x 14"
PX3D	11" x 17"



Specify:

Model — Orientation* — Color*
*Doesn't affect price.

Orientation*	Color*
H Horizontal	-S Satin Silver
V Vertical	-B Matte Black



Tabletop A Frame

Two hinged frames, Top entry, attractive twist chain.

PX1TAF	8-1/2" x 11"
PX2TAF	11" x 14"
PX3TAF	11" x 17"

Stand-Off Kits

Include set of 4 Brackets, wall anchors & screws. All Stand-Offs are 3" long.



SNSO	Snap/Easy Graphic Bar Stand-Off Kit
SOPK	Aluminum Puck Stand-Off Kit
EOSO	Snapframe Stand-Off Kit
PXSO	Perflex Frame Stand-Off Kit



-S Satin Silver **-B** Matte Black

Clipster™

Great for posters (.020" max.)

Modern, clean, techy look at a low price point.

Hang vertically or horizontally.



Wall or ceiling hanging.

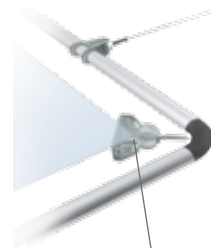

Spring tension clips grip poster securely.

WCF1	5-1/2" x 7"
WCF2	7" x 11"
WCF3	8-1/2" x 11"
WCF4	11" x 14"
WCF5	11" x 17"
WCF6	14" x 22"
WCF7	22" x 28"
WCF8	24" x 36"

-S Satin Silver **-B** Matte Black



Perfex SkyFrames™

STRONG, LIGHTWEIGHT - COST EFFECTIVE

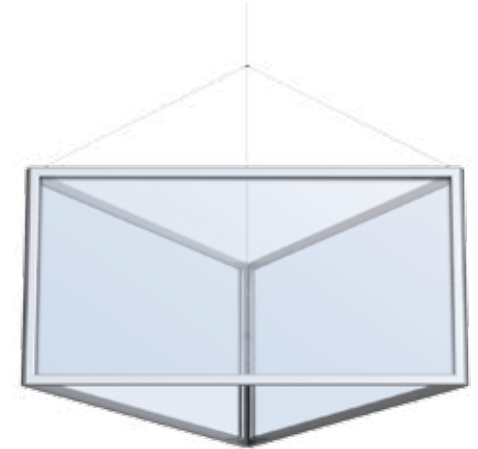
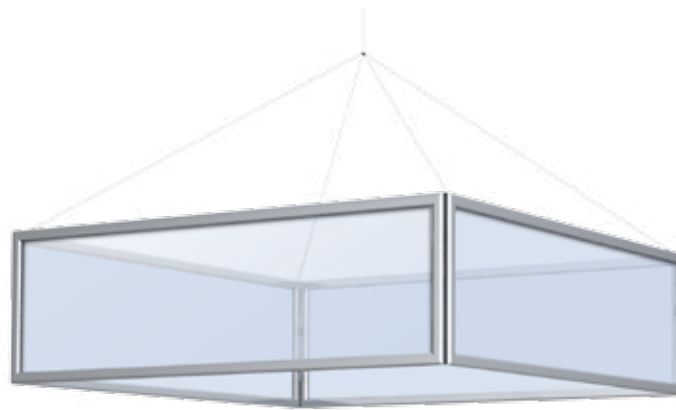
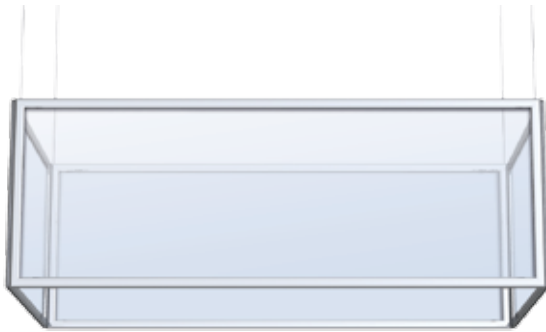

Four Sided Structures

Model:	W x H x D
SRCPX1	42" x 12" x 42"
SRCPX2	48" x 18" x 42"
SRCPX3	48" x 24" x 36"

-S Satin Silver -B Matte Black

Features:

- Contemporary curvilinear design
- Precision mitered corners
- Aluminum alloy construction
- 5 minute assembly
- Integral hanging hooks
- Accepts 3/16" full graphics
- Satin anodized finishes
- Easy side loading

Triangular Structures

Model:	W x H x D
STRPX1	36" x 18" x 36"
STRPX2	42" x 24" x 42"
STRPX3	48" x 30" x 48"

-S Satin Silver -B Matte Black

Aluminum Alloy

Cool curvilinear shape. Precision miters, handsome satin finishes.

Frames accept rigid graphics up to 3/16" full. Lenses are available to "sandwich" thin media.

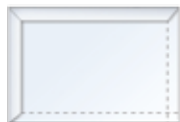

Live area:
3/8" margin covered by frame.



STEEL HANGING BRACES

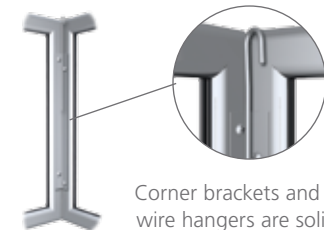

Corner brackets and welded wire hangers are solid steel.

Three and four sided hanging harness sets are available. As is a full range of other hanging hardware.



KIOSKS - 3D TOWERS

Attractive curvilinear alloy frames in handsome satin finishes. Integral steel braces ensure outstanding strength.

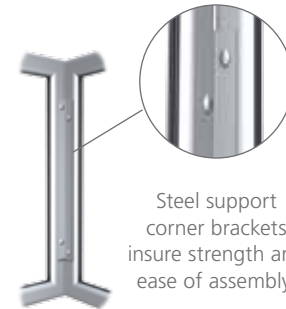

Steel support corner brackets insure strength and ease of assembly.



Features:

- Curvilinear profile
- Aluminum alloys
- Satin anodized finishes
- 5 minute assembly
- Top loading
- Accepts 3/16" full graphics

Triangular	Sides	H	Square	Rectangular	W x H x D
TRPX1	24"	x 48"	SQPX1	RCPX1	30" x 48" x 24"
TRPX2	24"	x 60"	SQPX2	RCPX2	30" x 60" x 24"
TRPX3	24"	x 72"	SQPX3	RCPX3	30" x 72" x 24"
TRPX4	30"	x 48"	SQPX4	RCPX4	36" x 48" x 24"
TRPX5	30"	x 60"	SQPX5	RCPX5	36" x 60" x 24"
TRPX6	30"	x 72"	SQPX6	RCPX6	36" x 72" x 24"

-S Satin Silver -B Matte Black

Many other sizes available.
Call our friendly sales staff for quotes.

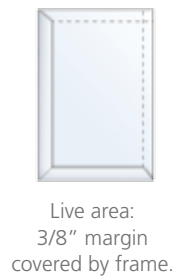

Live area:
3/8" margin
covered by frame.



Perfex Swivel Frames™

ALUMINUM SWIVEL FRAMES

All frames are vertically oriented and feature handsome satin finishes.
Holds graphics up to 3/16" thick.



3/8" margin is covered by the frame

< Ceiling Swivels

Includes a 9" standoff and a grid ceiling anchor.

PXCSV1	22" x 28"
PXCSV2	24" x 36"

-S Satin Silver or -B Matte Black

Wall Swivels >

Includes (2) 3" Standoffs and (2) 3-1/4" wall mounts.

PXWSV1	22" x 28"
PXWSV2	24" x 36"

-S Satin Silver or -B Matte Black

> Desk Swivels

Includes a 4" standoff and a 6-3/4" round base.

PXDSV1	8-1/2" x 11"
PXDSV2	11" x 14"
PXDSV3	11" x 17"

-S Satin Silver or -B Matte Black

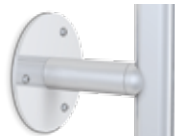

Strong construction

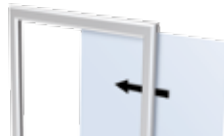

3/16" full open slots



Precision miters



Fully Adjustable



Create Collage Effects

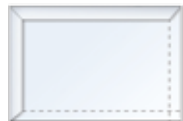

3/8" margin covered by the frame.

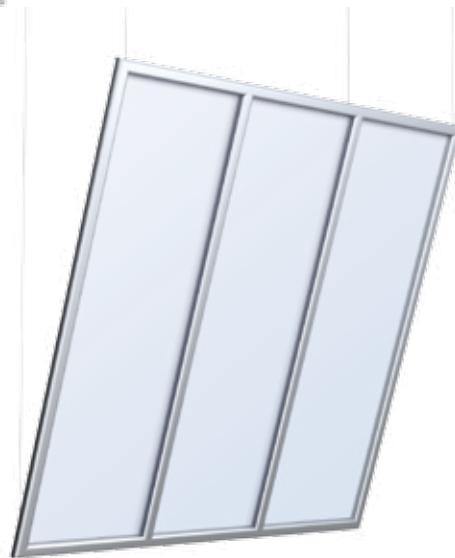

Clear lenses Sold in pairs.

CPL4	11" x 14"
CPL5	11" x 17"

CPL6	14" x 22"
CPL7	22" x 28"

MENU SYSTEM

Offered on a project basis, please contact our friendly sales staff with a sketch of what you would like quoted.



Wide variety of hanging holders.



Live More.
Talk to your pharmacist today.

Learn More >

Handsome finishes, satin silver or matte black.



3/16" full slot, side or top load.
For non rigid graphics, use CPL lenses.

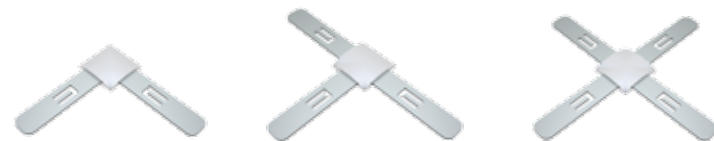

SIMPLY TAP TOGETHER FOR VERY EASY ASSEMBLY

Snap-On Perfex Stands™



SNAP ON ALUMINUM FRAMES

Pricing is offered on a project basis,
please contact our friendly sales staff
with a sketch of what you would like quoted.

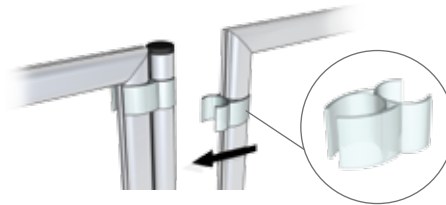

Satin anodized frames, aluminum tubes
snap together.

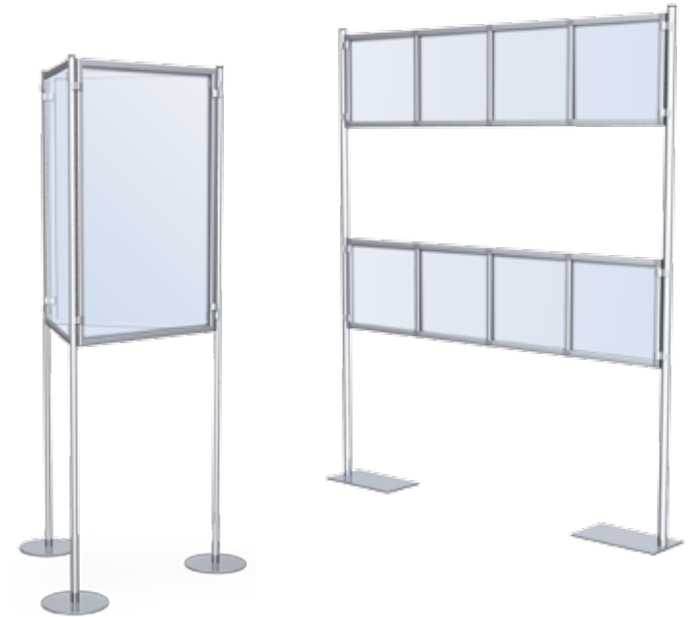

Swing Wing Perfex™

INFORMATION DISPLAYS

Perfect for:

Posters • Prints • Maps • Reference Materials • Sales Collateral

- All metal units
- Satin aluminum
- Built to last
- Pivots top & bottom

CUSTOM MODELS AVAILABLE

Although standard models have 5 or 10 frames per unit, custom units can have any number of frames.



Swing Frame Kiosk™

Easily flip through many posters. Small footprint. 10 satin silver frames. Back entry slots. Room for 3/16" thick materials plus lenses. 20" square base. Height 78". Wt: 55 lbs.

- WINGK1** (10) 22" x 28" frames
- WINGK2** (10) 24" x 36" frames
- WINGK3** (5) 22" x 28" frames
- WINGK4** (5) 24" x 36" frames



Wall Mount SwingWings™

Front mount, 10 satin silver frames. Room for 3/16" thick materials plus lenses. All metal.

- WING01** (10) 22" x 28" frames
- WING02** (10) 24" x 36" frames
- WING03** (5) 22" x 28" frames
- WING04** (5) 24" x 36" frames



TERRIFIC FOR: MUSEUMS - SCHOOLS - RETAIL - TRADESHOWS

Hanging Monster Frames™



STRONG, AESTHETICALLY BEAUTIFUL

- Jumbo aluminum profile
- Handsome matte finishes
- Top 1/4" full entry slots
- 1-1/4" w x 1" d
- Ships fully assembled
- Individually boxed

HANGING OPTIONS:



Metal eye bolts.



Corner brackets with holes.



Custom grid ceiling hanging option with **HD2** clip set.

Specify: Model–Hanging*–Color*

Model	Graphic Size
NSH1	14" x 22"
NSH2	22" x 28"
NSH3	24" x 36"
NSH4	30" x 40"
NSH5	36" x 48"

Hanging*	
WM	Wall Mount
CP	Ceiling Vertical
CL	Ceiling Horizontal

Color*	
-S	Satin Silver
-B	Matte Black

* Doesn't affect price, but must use to order.

HD2 Set of 2 clips. Grips onto frame and holds placards up to 1/8" thick.



Screw ensures miter will never separate.



Full 1/4" top entry slot.

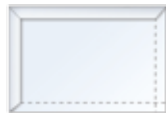

3/8" margin, 1-1/4" wide frame.



Clear lenses. Sold in pairs.

CPL6	14" x 22"	CPL7	22" x 28"
CPL6.5	18" x 24"	CPL8	24" x 36"

Monster Pedestal SignHolders™

GREAT FOR HIGH TRAFFIC VENUES

BUILT TO LAST!

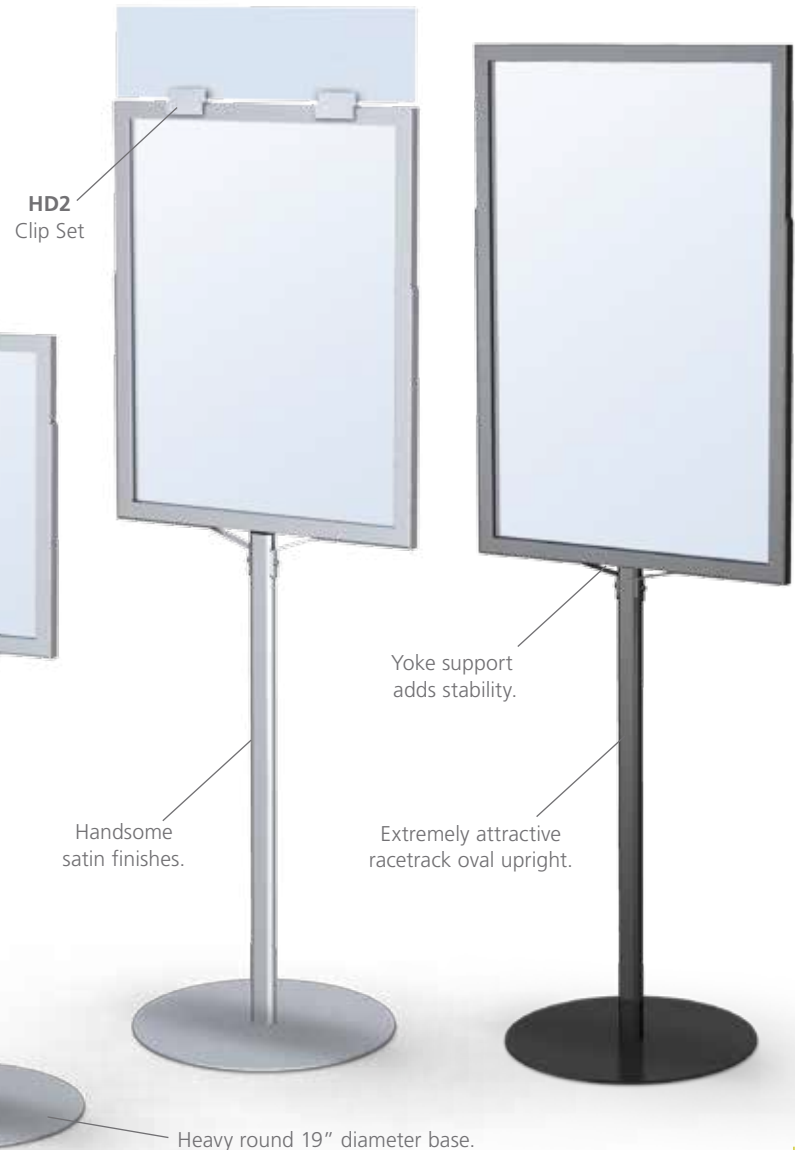

- Wide format alloy frame
- Racetrack oval upright
- 1/4" full top entry slot
- Ultra easy assembly
- 19" round, 15 lb. base
- Handsome matte finishes

NST1422	14" x 22"	59" h	19 lbs.
NST1824	18" x 24"	61" h	20 lbs.
NST2228	22" x 28"	65" h	20 lbs.
NST2436	24" x 36"	73" h	21 lbs.

-S Satin Silver -B Matte Black



< 19" round laser cut 15 lb. steel bases, solid double bolt connection.

Monster Frames™

LARGE FORMAT



HD2 Set of 2 clips. Grips onto frame and holds placards up to 1/8" thick.



MONSTER FRAMES

- Aluminum alloy racetrack oval uprights
- Specially designed heavy-duty alloy frame
- Two nine pound steel bases
- 1/4" full top loading for graphic insertion
- Rock solid double bolt upright to base connection

Frames ship ready to assemble, saving significantly on freight costs.

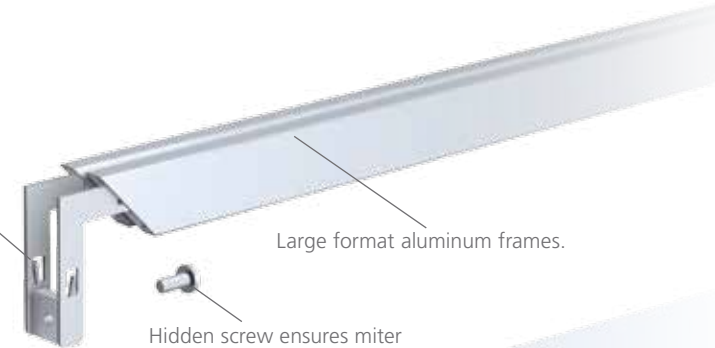

Large format aluminum frames.

Hidden screw ensures miter will never separate.

Textured endcaps.

Beautiful aluminum racetrack oval uprights.

CREATE MONSTER IMPACT!

Specify: Model (Size) - Orientation* - Color*

Model

NSTR1	36" x 48"
NSTR2	36" x 60"
NSTR3	36" x 72"
NSTR4	48" x 48"
NSTR5	48" x 60"
NSTR6	48" x 72"
NSTR7	60" x 60"
NSTR8	60" x 72"

Orientation*

H	Horizontal
V	Vertical

Color*

-S	Satin Silver
-B	Matte Black

*Not on price sheet
must use to order.

All units feature 1/4" full top entry slots.

Frame bottoms are 12" off floor, except 48" high models, which are 24" off floor.

Units ship K.D. ready to assemble.

Estimated assembly time - 8 minutes.

NOTE: Once assembled, units cannot be disassembled.

CUSTOM SIZES AVAILABLE

Units ship K.D.
ready to assemble.
Significant freight savings.



Racetrack oval
uprights

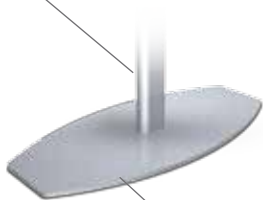

Marquise Base
18" long, 8-3/4" in the center
laser cut steel bases, solid double bolt connection.



Frames are 1/4" full top load
and 3/8 margin is covered
by the frame.

Specially designed
heavy duty frame.

Futura Perflex SignFrames™

Features:

- Sleek aluminum mitered frame
- Handsome satin finishes
- 1-1/2" diameter x 66" tall pole
- 13" Round, 7 lb. base
- Solid security base bushing
- Top entry slot



Easy assembly.
All metal construction.
Single frame option.



Curvilinear Shape.
Accepts 3/16" full substrates with
room for protective clear lenses.

**PRECISION
MITERED CORNERS**



Custom models
available.



FSP331-S



13" round base with
metal bushing for added stability.

FSP221	22 x 28"	1 Frame
FSP222	22 x 28"	2 Frames
FSP331	24 x 36"	1 Frame
FSP332	24 x 36"	2 Frames

Specify Color*

-S Satin Silver **-B** Matte Black

*Does not affect price

Clear lenses
sold in pairs.

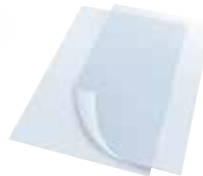

CPL7	22" x 28"
CPL8	24" x 36"



Live area:
3/8" margin is
covered by the frame.

Pamphlet Holders

4" wide by 2" deep pamphlets
9" wide by 2" deep catalog



PB3C



PB4C

MOUNT AND CHANGE GRAPHICS EFFORTLESSLY



Double frames attach easily to upright. View from both sides.

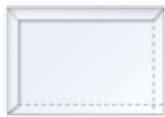

Live area:
3/8" margin is covered by the frame.

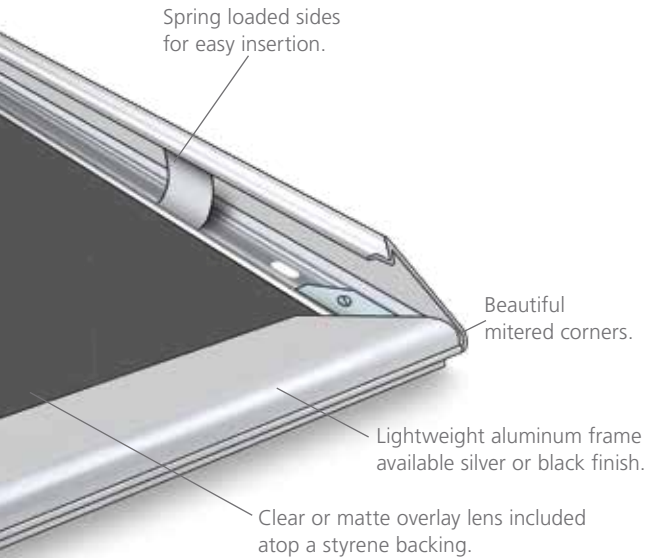

ULTRA CONVENIENT - FRONT LOADING!

Features:

- Aluminum Snap Frame
- Styrene back
- Clear or matte overlay lens included
- Handsome satin finishes
- 13" Round 7 lb. base
- Solid security base bushing
- Jumbo 1-1/2" diameter x 66" tall pole



Mitered Corners.



Radius Corners.

Mitered Corners

FME221	22" x 28"	1 Frame
FME222	22" x 28"	2 Frames
FME331	24" x 36"	1 Frame
FME332	24" x 36"	2 Frames

Radius Corners

FEO221
FEO222
FEO331
FEO332

Specify: Color* –Lens*

Color*

- S Satin Silver
- B Matte Black

Lens*

- C Clear
- M Matte

*Does not affect price.

Radius Snapframes accept substrates up to 1/8" thick, whereas our mitered units accept substrates only up to 1/32".

Pamphlet Holders

4" wide by 2" deep pamphlets
9" wide by 2" deep catalog



PB3C



PB4C



13" round base with metal bushing for added stability.

FEO331-S-C

CUSTOM MODELS AVAILABLE!

Poster SignHolders

22" X 28" DOUBLE SIDED VIEWING

Features:

- Aluminum construction
- Ultra easy assembly
- Top slot for easy insertion
- Handsome satin finishes
- Room for two 1/8" x 22" x 28" graphics

LF228 Double pole rectangular base 60" h 13 lbs.

-S Satin Silver -B Matte Black

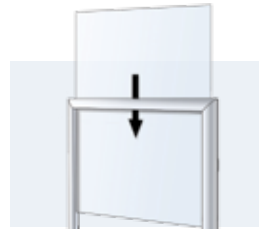

All units top load.

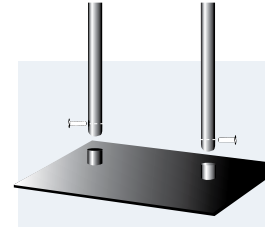

Bases have metal support bushings.



HD1 Clip Set (3) grips up to 1/8". Header not included.

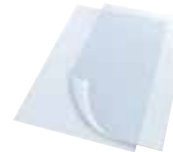

Clear lenses Sold in pairs. **CPL7** 22" x 28"



SLB Lit. Baskets 11" x 17" tabloids or two 8-1/2" x 11" side-by-side stacks.



LF228-S with **SLB** Lit. basket & **HD1** header clips.



LF2LT3-S
with HD1

CLIP ON COLLATERAL HOLDERS

Crystal Clear Plastic

Pamphlet Holders are 4-3/8" wide x 1-1/2" deep

Catalog Holders are 9-1/4" wide x 1-1/2" deep

Includes pocket dividers that separate cavity for pamphlet use.



Catalog Holders include a removable divider.

1 OR 2 SIDED INFORMATION CENTERS

Features:

- Aluminum construction
- Ultra easy assembly
- Top slot for easy insertion
- Handsome satin finishes
- Room for two 1/8" x 22" x 28" graphics

LF2LT1 Signholder with 5 Pamphlet Holders on 1 side.

LF2LT2 Signholder with 10 Pamphlet Holders, 5 each side.

LF2LT3 Signholder with 2 Catalog Holders on 1 side.

LF2LT4 Signholder with 4 Catalog Holders, 2 each side.

-S Satin Silver -B Matte Black



LF2LT1-B

Titan Poster SignHolders™

TITAN POSTER SIGNHOLDERS™

EXTRAORDINARILY STRONG, STABLE & YET PORTABLE.

Features:

- All Aluminum construction
- Ultra easy assembly in minutes
- Top slot (1/4") for easy insertion
- Handsome satin finishes
- Room for two 1/8" x 22" x 28" or 24" x 36" graphics

Model	Style	Base	Graphics	Ht.	Wt.
LF128	Single Pole	17" Round	(2) 22" x 28"	65"	22 lbs.
LF136	Single Pole	17" Round	(2) 24" x 36"	65"	23 lbs.

-S Satin Silver -B Matte Black



Graphics top load.



Metal yoke insures structural integrity.



Radius corners are aesthetically beautiful.



Laser cut round base double bolt connection.



Beautiful racetrack oval upright.

EXTREMELY STRONG, AESTHETICALLY BEAUTIFUL



Suitable for high traffic areas.



OPEN FRAMES
TWO-SIDED
VIEWING

LF128-S

Accessories:



HD1 Clip Set (3)
grips up to 1/8".
Header not included.



Clear lenses
Sold in pairs.
CPL7 22" x 28"



SLB Lit. Baskets
11" x 17" tabloids or two
8-1/2" x 11" side-by-side stacks.

Poster SignHolders

LF328 - POSTER SIGNHOLDERS

- All Aluminum construction
- Top slot (1/4") for easy insertion
- Room for two 1/8" x 22" x 28" graphics
- Ultra easy assembly in minutes
- Handsome satin finishes
- Height: 63" • Wt: 11 lbs.

-S Satin Silver -B Matte Black



Electrically-welded, all metal extremely durable construction.



HD1 Clip Set (3) grips headers up to 1/8".



Clear lenses Sold in pairs. **CPL7** 22" x 28".



SLB3 Lit. Baskets hold (1) 11" x 17" tabloids or (2) 8-1/2" x 11" stacks.

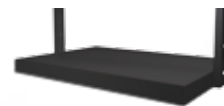

Weighted Cover for LF3's. 21 lb. Sits atop base. **LFWC1** -S Silver -B Black



Communication Centers

COLLATERAL SIGNHOLDERS

- Terrific quality, all metal LF3 22" x 28" Signholder
- Crystal clear plastic compartments
- Pamphlet Holders are 4-3/8" wide x 1-1/2" deep
- Catalog Holders are 9-1/4" wide x 1-1/2" deep, includes pocket dividers for pamphlet use.

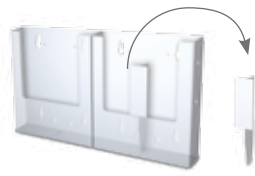

Catalog Holders include a removable divider dart.



Units attach to signholders by simply clipping onto crossbar.

UNITS ARE 63" HIGH

Those with Holders on 1 side are 13 lbs.
Those with Holders on 2 sides are 15 lbs.



LF3LT1-S

- LF3LT1** 5 Pamphlet Holders on 1 side.
- LF3LT2** 10 Pamphlet Holders, 5 each side.

- LF3LT3** 2 Catalog Holders on 1 side.
- LF3LT4** 4 Catalog Holders, 2 each side.

-S Satin Silver -B Matte Black

INFO CENTERS

- Great quality, economical price point
- Aluminum construction
- Electrically welded bases
- Clear plastic holders
- Pamphlet & catalog sizes
- Back to back displays

- LFPB140** Room for 40 Pamphlets
- LFPB216** 16 catalogs or 32 pamphlets

-S Satin Silver -B Matte Black



Clips (3) included holds headers to 1/8" thick.

LFPB216-B

LFPB140-S

Poster SignHolders

GREAT FOR LARGE VENUES

- Lightweight aluminum construction
- Electrically welded bases with steel inserts
- Satin powder coated matte finishes
- Extremely portable yet durable
- Great for fast and easy graphic change-outs
- Load graphics facing out-both sides



TLT33-B



L2284-B



L2256-S



L2328-S



L3328-S

Model	Capacity	Ht.	Wt.
L2256*	(2) 22" x 56"	62"	12 lbs.
L2284*	(2) 22" x 84"	88"	13 lbs.
L2328	(4) 22" x 28"	63"	12 lbs.
L3328	(6) 22" x 28"	89"	14 lbs.

*Require rigid media, 1/4" max.

-S Satin Silver -B Matte Black

Model	Type	Capacity	Ht.	Wt.
TLT31	1-tilter	(2) 22" x 28"	67"	11 lbs.
TLT32	2-tilter	(4) 22" x 28"	67"	13 lbs.
TLT33	3-tilter	(6) 22" x 28"	89"	14 lbs.

Weighted Covers

LFWC1 21 lbs. - LF328, LFPB, L2256, L2328-S
LFWC2 28 lbs. - L2256, L2284, L3328

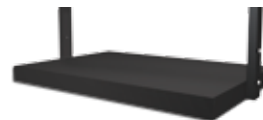

CPL7 22" x 28"
 Clear lenses (pairs).



ECONOMY FOLDING A FRAMES

- Aluminum frames, legs and stays
- Units collapse & fold
- 2-1/2" x 2-1/2" x 44-1/2" closed
- Accepts graphics up to 1/4" thick
- Top entry slot, non-slip tips
- Weight only 5-1/2 lbs.

Hold substrates up to 1/4" thick.



AF24-S Opened

Food service, promotional messages, retail signage and more.



AF22 Closed



AF22 Half open

Collapsible side, front and back crossbars.

Top load slots.

Extruded aluminum legs have built in frame rails.

Non-slip tips.

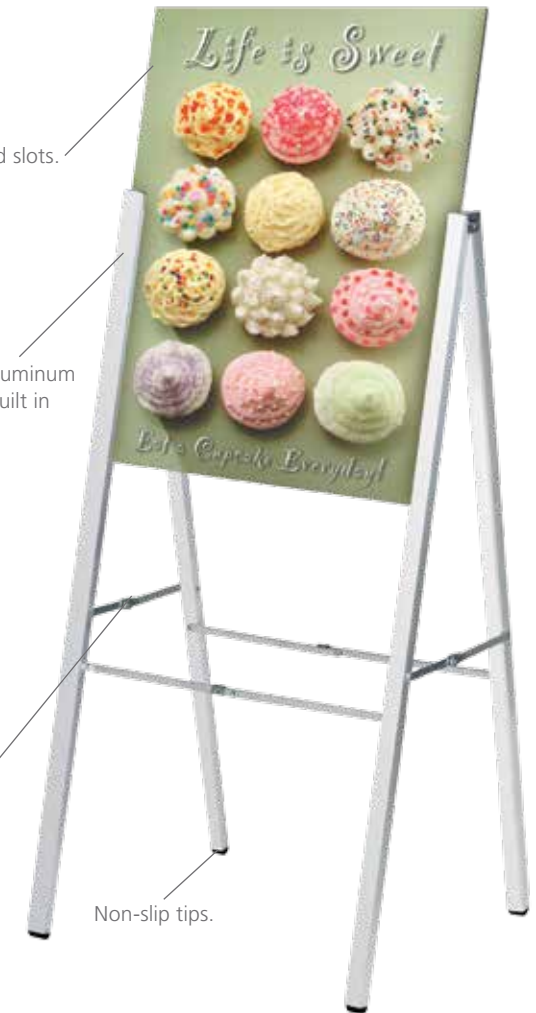

AF22-S	22" x 28"	AF22-B	22" x 28"
AF24-S	24" x 36"	AF24-B	24" x 36"

-S	Satin Silver
-B	Matte Black

Note: Black units are more costly than the silver.

Perfex A Frames

DOUBLE SIDED, FULLY ASSEMBLED.

- Perfex aluminum curvilinear frames
- Aluminum extruded legs
- Ruggedly built - designed to last
- Heavy duty support stays
- Non-skid rubber bumpers
- 44-1/2" Closed, 43" Open



Standard models top load.

AFP22-S



Cool Curvilinear Shape.
Accepts 3/16" substrates with room for protective clear lenses.

Standard		with Headers
AFP22-S	22" x 28" Silver	AFPH22-S
AFP22-B	22" x 28" Black	AFPH22-B
AFP24-S	24" x 36" Silver	AFPH24-S
AFP24-B	24" x 36" Black	AFPH24-B

-S Satin Silver or -B Matte Black*
*Black units are more costly than the silver.



AFPH22-S

Header graphic size:
22" x 8" or 24" x 8".

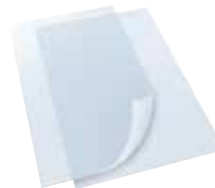

Clear or Matte lenses. Sold in pairs.

CPL7 Clear	CPM7 Matte	22" x 28"
CPL8 Clear	CPM8 Matte	24" x 36"

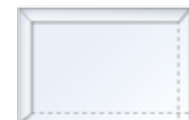

Live area: 3/8" margin covered by the frame.

A Frame SnapFrames

ULTRA CONVENIENT - FRONT LOADING



All units are double sided and fully assembled.

- Easy-Open Snap Frames
- Styrene back
- Clear or matte overlay lens included
- Non-skid rubber bumpers
- Heavy duty support stays
- 44-1/2" Closed, 43" Open

Mount and change graphics effortlessly.

Mitered Corners		Radius Corners	
AME22-S	22" x 28" Silver	AEO22-S	
AME22-B	22" x 28" Black	AEO22-B	
AME24-S	24" x 36" Silver	AEO24-S	
AME24-B	24" x 36" Black	AEO24-B	

Specify: Color-Lens*

Color

- S Satin Silver
- B Matte Black

Lens*

- C Clear
- M Matte

Black units are more costly than the silver.

*Does not affect price.

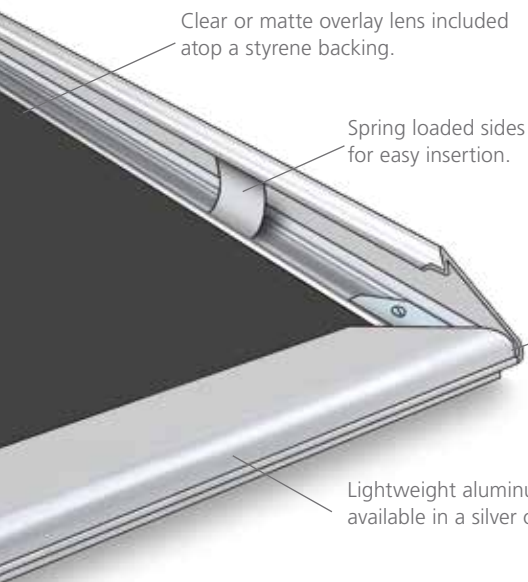

Clear or matte overlay lens included atop a styrene backing.

Spring loaded sides for easy insertion.

Beautiful mitered corners.

Lightweight aluminum frame available in a silver or black finish.

Radius Snapframes accept substrates up to 1/8" thick, whereas our mitered units accept substrates only up to 1/32".



Live area: 3/8" margin covered by the frame.



AEO24-S

Convex Poster SignHolders

Extremely easy front graphic installation.



VX1-B



VX1-S

ATTRACTIVE CURVED UNITS DEMAND ATTENTION

Graphic changes are effortless and assembly is ultra simple.

Suitable for high traffic areas.

Convex Poster SignHolders

Dramatic, stylish, elegant two sided curved design. Perfect for exhibits, retail, restaurants, trade shows and malls.

Accepts semi-rigid or rigid self supporting 22" x 28" graphics up to 1/16" thick. Styrene is ideal.

Change out graphics instantly without disassembling unit!

Use .040" semi rigid media minimum, 1/16" (.060") suggested.

1/2" margin on each side, viewable live area 21" wide.

Model	Style	Base	Graphics	Ht.	Wt.
VX1	Single	17" Round	(2) 22"x 28"	66"	19 lbs.
VX2	Double	Elliptical	(4) 22"x 28"	58"	18 lbs.
VX3	Triple	Elliptical	(6) 22"x 28"	86"	23 lbs
VX4*	Long	Elliptical	(2) 22"x 56"	57"	16 lbs.
VX5*	Extra-Long	Elliptical	(2) 22"x 84"	85"	21 lbs

-S Satin Silver

-B Matte Black

*VX4 & VX5 require .060" (1/16") semi rigid media, thinner will collapse. HIPS Styrene ideal. Maximum .090" (3/32").



VX2-B

QUICK CHANGE GRAPHICS - DOUBLE SIDED VIEWING!

MODERN CONTEMPORARY LOOK

Convex signholders have strong visual impact.
Extremely easy front load graphic installation & change out.



VX4-S



*VX4 & VX5 require .060" (1/16") semi rigid media,
thinner will collapse. HIPS Styrene ideal. Maximum .090" (3/32").

DOUBLE AND TRIPLE UNITS HAVE ELLIPTICAL BASES



VX5-S



VX3-S

Convex Wall Mount SignHolders

CURVED UNITS DEMAND ATTENTION

Convex Poster SignHolders

Standard Poster size. Dramatic, stylish, elegant curved design.

Wall Mount

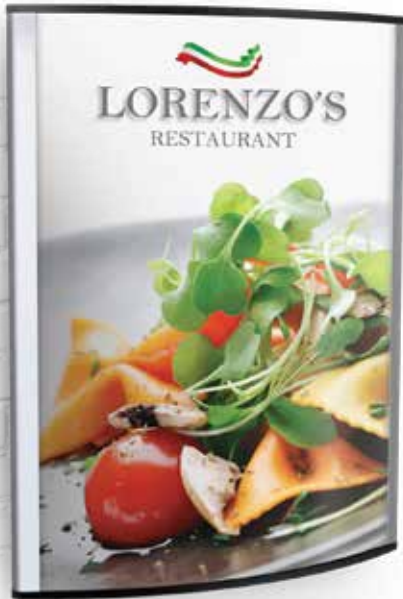

CounterTop



Eclipse Wall Mount™

Accommodates standard paper sizes.



Hanging hardware and lens included.

Custom sizes available.

Accepts semi-rigid 22" x 28" graphics in an attractive curved shape.
We strongly recommend you use .060" Styrene.

Graphic changes are effortless and assembly is ultra simple.

Wall mount units include brackets, anchors and screws.

WE1	11" w x 8-1/2" h
WE2	8-1/2" w x 11" h
WE3	14" w x 11" h

WE4	11" w x 14" h
WE5	17" w x 11" h
WE6	11" w x 17" h

Specify:

-S Satin Silver **-B** Matte Black

Wall Mount	CounterTop	Size	Color
VXWM1	VXCT1	22" w x 28" h	-S Satin Silver
VXWM2	VXCT2	22" w x 28" h	-B Matte Black

PERFECT FOR EXHIBITS, RETAIL,
RESTAURANTS AND MALLS.

GREAT FOR MALL USE!

Plastic lenses

Sold in pairs.

Clear	Matte	Size
CPL3	CPM3	8-1/2" x 11"
CPL4	CPM4	11" x 14"
CPL5	CPM5	11" x 17"
CPL6	CPM6	14" x 22"
CPL6.5	CPM6.5	18" x 24"
CPL7	CPM7	22" x 28"
CPL8	CPM8	24" x 36"

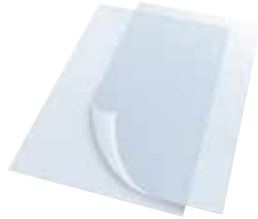

Coroplast® Backs

White, 4 mm corrugated plastic boards make excellent frame backs. Sold individually.

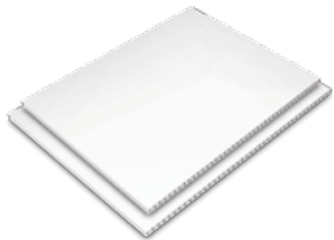

COR3	8-1/2" x 11"
COR4	11" x 14"
COR5	11" x 17"
COR6	14" x 22"
COR6.5	18" x 24"
COR7	22" x 28"
COR8	24" x 36"

Coroplast® - Lens Combo Packs

Includes one 4 mm corrugated plastic board and two clear lenses.

Clear	Matte	Size
COPL3	COPM3	8-1/2" x 11"
COPL4	COPM4	11" x 14"
COPL5	COPM5	11" x 17"
COPL6	COPM6	14" x 22"
COPL6.5	COPM6.5	18" x 24"
COPL7	COPM7	22" x 28"
COPL8	COPM8	24" x 36"



ATLAS1 28" w x 78" h x 18" d Specify: **-S** Satin Silver **-B** Matte Black

Eclipse SignHolders™

ECLIPSE TABLETOP SIGNHOLDERS

- All metal modern construction
- Includes a non reflective matte lens!
- Satin silver or matte black
- Custom sizes available

Accepts standard paper thicknesses.

Simply place your printed graphics behind the supplied lens.



Great for food service, hospitality, product identification, prices, instructions, promotional messages, retail signage and more.

Models TC1 thru TC7 made from a solid aluminum extrusion.

Model	Per	W" x H" (Insert Size)
TC1	12	1" x 3/4"
TC2	5	3-1/2" x 2"
TC3	5	8" x 2"
TC4	5	4-1/4" x 2-1/2"
TC5	5	2-1/2" x 4"
TC6	5	4" x 4"
TC7	5	6" x 4"

Specify:

-S Satin Silver -B Matte Black

Models TC8 thru TC11 have aluminum extrusions top & bottom with a formed steel back.

Model	Per	W" x H" (Insert Size)
TC8	Each	11" x 8-1/2"
TC9	Each	8-1/2" x 11"
TC10	Each	14" x 11"
TC11	Each	11" x 14"

Specify:

-S Satin Silver -B Matte Black



ArcTop SignHolders™

ARCTOP SIGNHOLDERS

- Aluminum alloy bases
- Handsome satin finishes
- Elegant, contemporary design
- Individually polybagged / bulk packed

EasyGraphic Gripper accepts rigid media up to 1/8" thick.



Base Styles:

Upright



← Upright 4" Deep →

Angled



← Angled 4" Deep →

UNITS WITH LENSES

For regular paper stock.
Use printers and copiers.

Model	Graphic W" x H"
AT01	7" x 5-1/2"
AT02	5-1/2" x 7"
AT03	11" x 7"
AT04	7" x 11"
AT05	11" x 8-1/2"
AT06	8-1/2" x 11"
AT07	14" x 11"
AT08	11" x 14"
AT09	17" x 11"

Select: Model (size), Style: Upright or Angle Back (U/A), Color: Silver or Black.

Style*

U	Upright
A	Angled

Color*

-S	Satin Silver
-B	Black Matte

*Does not affect price.

BASE ONLY, NO LENSES

For rigid & semi-rigid graphics
up to 1/8" thick.

Model	Width
AT11	5-1/2"
AT12	7"
AT13	8-1/2"
AT14	11"
AT15	14"
AT16	17"

Select: Model (size), Style: Upright or Angle Back (U/A), Color: Silver or Black.

Style*

U	Upright
A	Angled

Color*

-S	Satin Silver
-B	Black Matte

*Does not affect price.



CUSTOM SIZES & COLORS AVAILABLE

CounterTop SignHolders

Double **JL**Mounts™

Heavy steel with 1/4" graphic slots.
1" high, 4" deep, powder coated.
Floor Double LL's on pg. 150.

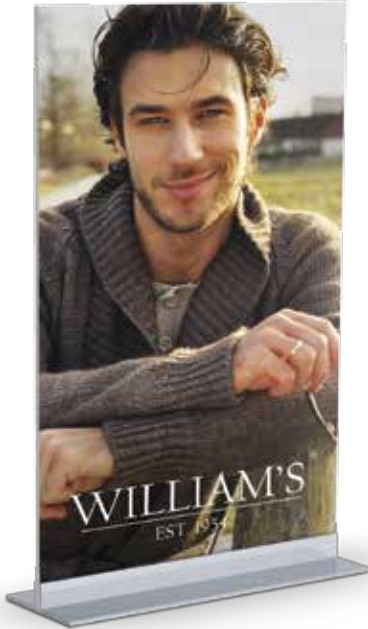

Simply insert graphic
4" deep, 1" high.

Model	Length	Model	Length
LLT85	8-1/2"	LLT17	17"
LLT11	11"	LLT24	24"
LLT14	14"	LLT30	30"

-S Satin Silver -B Matte Black

Super **CLICK** Mounts™

Aluminum extruded shapes.
Snap open to hold graphics from
1/32" to 1/4" thick. Smart satin finishes.

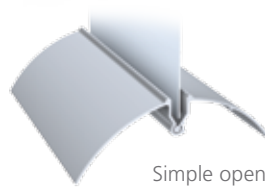

Simple open & close design
3-1/4" deep, 1" high.

Model	Length	Model	Length
SCM35	3-1/2"	SCM85	8-1/2"
SCM55	5-1/2"	SCM11	11"
SCM7	7"	SCM14	14"

-S Satin Silver -B Matte Black

Mini **Mightee**™

Steel base holds rigid graphics
up to 3/16" thick. 12" long.
Floor MighteeMounts on pg. 148.

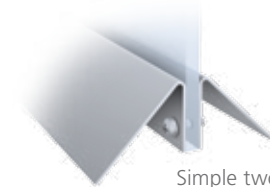

Simple two screw connection
3-3/4" deep, 1-5/8" high.

Model	Length	Wt.
MM12	12"	1-1/2 lbs.

-S Satin Silver -B Matte Black

ALUMINUM TABLE EASELS

Lightweight, strong aluminum alloy with non skid rubber feet.



Model	Description
145	Small easel, Ht. 13" folds, polybagged
145S	Same as 145, with 1/2" deep tray
151	Multipurpose, Ht. 19", polybagged
152	Same as 151, but with top bar, boxed

PERFEX COUNTERTOP FRAMES

Aluminum, curvilinear frames, 3/16" top loading, satin finishes, steel bases with felt bottoms.



Clamp-On Base

Metal clamp, for round tubes to 1-3/4" or flat surfaces to 2-1/4" thick. 4" riser.

Model	Size
PX1G	8-1/2" x 11"
PX2G	11" x 14"
PX3G	11" x 17"



Curvilinear Matte Black



Table Top Round Base

6-3/4" round base, 4" riser. Top entry slot.

Model	Size
PX1T	8-1/2" x 11"
PX2T	11" x 14"
PX3T	11" x 17"



Rectangular Base

Steel base, felt feet. Top entry slot.

Model	Size	Base
PX1R	8-1/2" x 11"	4" x 6"
PX2R	11" x 14"	4" x 8"
PX3R	11" x 17"	4" x 8"
PX4R	14" x 22"	4" x 12"



Curvilinear Satin Silver

Specify: Model — Orientation* — Color*

Orientation*	Color*
H Horizontal	-S Satin Silver
V Vertical	-B Matte Black

*Doesn't affect price.

CounterTop Banner Stands

TELESCOPIC COUNTERTOP BANNER STANDS

Adjustable to 42" high.



Side by Side



Cantilevered



Trouble free lock allows quick height adjustments.



CT BANNER STANDS

- Classic styling
- 3/8" diameter dowels
- Faceout ends hold banners
- Satin matte finishes
- Telescopic uprights 24"- 42"
- 8" square, felt bottom bases

Also use as Bag & Scarf Holders.

Side by Side

CT26	6" Dowels
CT29	9" Dowels
CT212	12" Dowels
CT218	18" Dowels

Specify Color*

<	-S	Satin Silver	>
	-B	Matte Black	

*Doesn't affect price.

Cantilevered

CTV6	6" Dowels
CTV9	9" Dowels
CTV12	12" Dowels
CTV15	15" Dowels

CLASSIC BANNER STAND

- 8" square base
- Holds 1 or 2 banners
- 12" wide banners
- 1/2" diameter dowels
- 24"-42" telescopic height

Model Telescopic Height

BN1	24 - 42"
------------	----------

-S Satin Silver -B Matte Black

COUNTERTOP SIGNHOLDERS

Uprights are 3/4" diameter x 28" high. Choose either round, square or clamp base- (metal clamp, suitable for round tubes to 1-3/4" and flat surfaces to 2-1/4" thick). Available satin silver or matte black finish.



Aluminum Clamps

CTVCT1RD-S

CLAMP STANDS

- Solid aluminum alloy
- Grips up to 1/2" thick
- 2"w x 3"h, rubber lined
- Adjustable up & down

CTVCT1 One sided clamp stand

CTVCT2 Two sided clamp stand

Specify: -Base* -Color*



Signs adhere to Snap On Hook/Loop Bracket.

CTPS1CO-S

PLACARD STANDS

- Easy to use Hook /Loop Snap On brackets
- Holds lightweight placards front & back

CTPS1 Placard Stand (2 sided)

Specify: -Base* -Color*

Base*

RD 6-3/4" Round base

SQ 8" Square base

CO VEE Clamp-On base

Color*

-S Satin Silver

-B Matte Black



Metal Sign Holders



CTSE2SQ-S

SIGN EASELS

- Holds placards and signs up to 1/4" thick
- Single or double sided

CTSE1 One sided sign easel

CTSE2 Two sided sign easel

Specify: -Base* -Color*

Three Common Base and Two Color Choices >

* Does not affect price.

CounterTop SignHolders

All CounterTop Stands are individually polybagged.



WIRE LOOP HOLDERS

- Metal loops
- Silver finish
- 3" round metal bases

WL2	6"
WL3	12"



MINI CLIP SIGNHOLDERS

All metal units
Bases have felt bottoms.

Specify: Pole - Base* - Neck* - Color*

Pole

SC1	8" height (3/16" diam.)
SC2	18" height (3/16" diam.)
SC5	14" - 24" telescopic

Base*

RD	3" round
SQ	4" square

Neck*

A	Angle
G	Gooseneck
ST	Straight

Color*

-S	Satin Silver
-B	Matte Black

*Doesn't affect price.

MINI WIRE BANNERSTANDS

Weighted steel bases with felt bottoms. Welded all metal construction. 1/4" wires with turned up ends.

Model	Banner Width	Wire Height	Steel Base
MS613	6"	13"	4" x 4"
MS619	6"	19"	4" x 4"
MS919	9"	19"	6" x 4"
MS925	9"	25"	6" x 4"
MS1225	12"	25"	6" x 4"

Specify: — *Color *Doesn't affect price.

-S	Satin Silver	-B	Matte Black
----	--------------	----	-------------

CUSTOM SIGNHOLDERS

Can be offered on a project basis in quantity.



CounterTop SignHolders



MERCHANDISING CLAMPS

- Solid aluminum alloy
- Anodized satin finishes
- 2" w x 3" h, rubber grips
- Grip range up to 1/2" thick

VCTP	-S Satin Silver
	-B Matte Black



MAGNETIC SPINNERS

3-1/4" round, strong magnetic base assembly

- 18" high aluminum tubes
- Strong clear grips
- Graphics up to 1/8" thick

Great for Signage on cars and other steel surfaces.

SPIN1	-S Satin Silver
	-B Matte Black

*Color does not affect price.



SIGNPOST TABLE GRIPS

- 18" high, sturdy oval upright
- Clear clips hold semi-rigid & rigid graphics up to 1/8" thick

Quick graphic change-outs. Perfect for Point-of-Sale.

YCT1	2 Grips (1 Sided)
YCT2	4 Grips (2 Sided)

CounterTop Message Boards

Perfect for the
food service industry

WET ERASE MENU BOARDS

- Matte black acrylic writing surface
- Use wet erase markers
- Satin anodized aluminum alloy black
- Modern & contemporary
- Individually polybagged, bulk packed.



Black acrylic writing surface contrasts beautifully in the satin anodized aluminum.



Model	Size (w x h)	Style	Border	Writing Surface
KSL1	5" x 5"	L Back	1/2"	4" x 4"
KSL2	8" x 10"	L Back	1/2"	7" x 9"
KSL3	11" x 14"	L Back	1/2"	10" x 13"
KSL4	11" x 17"	L Back	1/2"	10" x 16"
KSL5	18" x 12"	L Back	1"	16" x 10"
KSL6	24" x 18"	L Back	1"	22" x 16"
KSA1	8" x 10"	A Tent	1/2"	7" x 9"
KSA2	11" x 14"	A Tent	1/2"	10" x 13"
KSA3	16" x 4"	A Tent	1/2"	15" x 3"

PLASTIC POCKET / METAL BACKS

- Durable clear plastic pockets
- Matte black steel black
- Accepts standard paper sizes
- Modern, contemporary look
- Individually polybagged, bulk packed.



- Top load
- Integrated plastic pocket
- Matte black steel back

Model	Graphic Size (w x h)
KPP1	8-1/2" x 11"
KPP2	11" x 14"
KPP3	11" x 17"

All units are vertically oriented.

PRINT AND DISPLAY YOUR OWN SIGNAGE

CounterTop SignBacks

METAL SIGNBACKS

- Heavy Steel Backs
- Matte black finish
- Accepts standard paper sizes & thicknesses (1/16" max.)
- Size, orientation & upright choices
- All SignBacks are individually polybagged



All Metal

Welded steel frames offer strength and durability at value price points.

Specify: Graphic Size—Single or double sided—Stem—Orientation*—Base*

Graphic Size:	Single or Double sided:	Stem:	Orientation*:	Base*:
SB3 8.5" x 11"	-1 Single Sided	X Fixed 18"	H Horizontal	Q 6" Square
SB4 11" x 14"	-2 Double Sided	T Telescopic 11" to 18"	V Vertical	L 4" x 7" Shovel
SB5 11" x 17"				W 4" Square screw down

*Does not affect price.

Framettes™

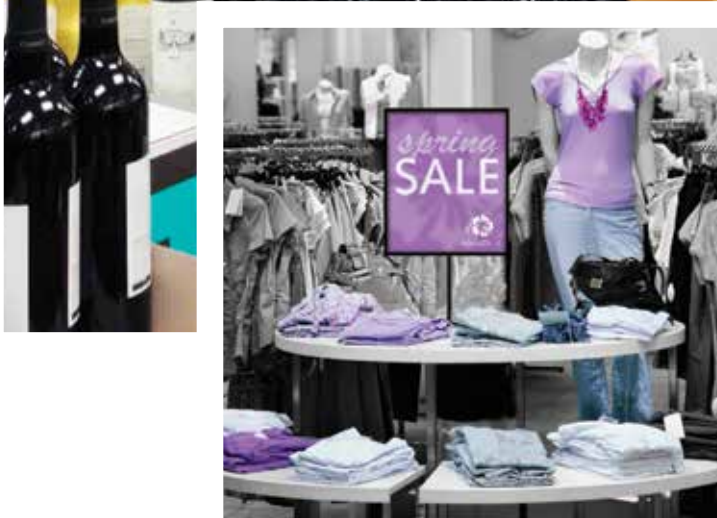

All Metal!

Framettes

... effective in-store advertising!



PEDESTAL FRAMETTES

- 5/32" inside dimensional frames, top entry slots
- All metal, satin matte black powder coated finish
- Choices include size, orientation, fixed or telescopic uprights
- All Framettes are individually poly-bagged, then bulk packed



Welded steel frames offer strength and durability at value price points.



Custom Requests Encouraged.

Open, drop-in, welded steel, matte black frames



Frame Size:	
FT3	7" x 11"
FT4	8.5" x 11"
FT5	11" x 14"

Stem:	
X	Fixed 12"
T	Telescopic 11" to 18"

Orientation*:	
H	Horizontal
V	Vertical

Base*:	
Q	6" Square
L	4" x 7" Shovel
W	4" Square screw down

Specify: Frame Size—Stem—Orientation*—Base*

*Does not affect price.

Framettes™

DROP-IN, WELDED STEEL, MATTE BLACK FRAMES

Magnetic Framettes

Strong channel magnet, 2-3/4" wide, 25 lb. rated pull strength.

FTMB1	7" x 11"
FTMB2	8-1/2" x 11"
FTMB3	11" x 14"

Specify:

-H Horizontal -V Vertical



FTMB3-H

Topper Framettes

Good for general countertop use. 3" wide base.

FTTP1	7" x 11"
FTTP2	8-1/2" x 11"
FTTP3	11" x 14"

Specify:

-H Horizontal -V Vertical



FTTP2-H

Clamp Base Framettes

Non Telescopic Pole
12" high poles, with clamp base.

FTCX1	7" x 11"
FTCX2	8-1/2" x 11"
FTCX3	11" x 14"

Specify:

-H Horizontal -V Vertical



FTCT3-H

Countertop Framettes

For higher end applications.
Full width deep bases with felt bottoms, 4" high stand-offs.

FTVM1	7" x 11"
FTVM2	8-1/2" x 11"
FTVM3	11" x 14"

Specify:

-H Horizontal -V Vertical



FTVM3-V

Wall Mount Framettes

Electrically welded tabs for wall mounting. Top loading.
Screws & wall anchors included.

FTWM1	7" x 11"
FTWM2	8-1/2" x 11"
FTWM3	11" x 14"

Specify:

-H Horizontal -V Vertical



FTWM2-H

Clamp is all metal, designed to hold to flat or round surfaces.
Has a grip range of 2-1/4" open.

Telescopic Pole
11" closed, 18" open
Frame with clamp base.

FTCT1	7" x 11"
FTCT2	8-1/2" x 11"
FTCT3	11" x 14"

Specify:

-H Horizontal -V Vertical

Slatwall Framettes

Metal "Z" brackets electrically welded. Fits standard slatwall.

FTSW1	7" x 11"
FTSW2	8-1/2" x 11"
FTSW3	11" x 14"

Specify:

-H Horizontal -V Vertical



FTSW3-H

Custom Framettes

Customized options and colors in quantity. Contact our sales staff with specifications.



- Size
- Swivels
- Round Base
- Stem sizes
- Side mounts
- Wire grid mounts

Custom Colors:

- From Speckles to designer shades
- Wide spectrum of powder coated colors available
- Reference Pantone color chart to match corporate colors





All Metal!

Framettes

... effective in-store advertising!

SnapGraphic Grippers™



Grip Graphics up to 70 mil (.070") thick.

Ingenious gripper snaps closed after graphic insertion with incredible strength, torque and care.

Patented!

U.S. Utility Patent # 6,637,716
U.S. Design Patent # D-424,120

Features:

- Beautifully finished aluminum case
- No pockets or graphic end treatment required
- Designed to close easily once graphic is inserted
- Ideal for large signage, reusable



SOLD AS A KIT
Top & bottom crossbar with 2 universal hanging clips.



Wide variety of hanging holders available.



UC180
Steel Brackets
Set of 4. Allows casings to be joined in series.



UC44
Wall Mount Kit for SN1 & SN2
Set of 4.



UCSP
Aluminum Screw Posts, set of 2. For thick graphics (up to 3/8"), use in place of gripper.

Specify: Case—Length—Color*

Case

SN1	Oval
SN2	Rectangular
SN3	Oval, long
SN4	Rectangular, long

Length

1 - 18"	4 - 28"	7 - 60"
2 - 22"	5 - 36"	8 - 72"
3 - 24"	6 - 48"	9 - 96"

Custom lengths available

Color*

-S	Satin Silver
-B	Matte Black

*Does not affect price, but must use to order.



AB Adhesive back models available. Same cost as models with hanging clips.

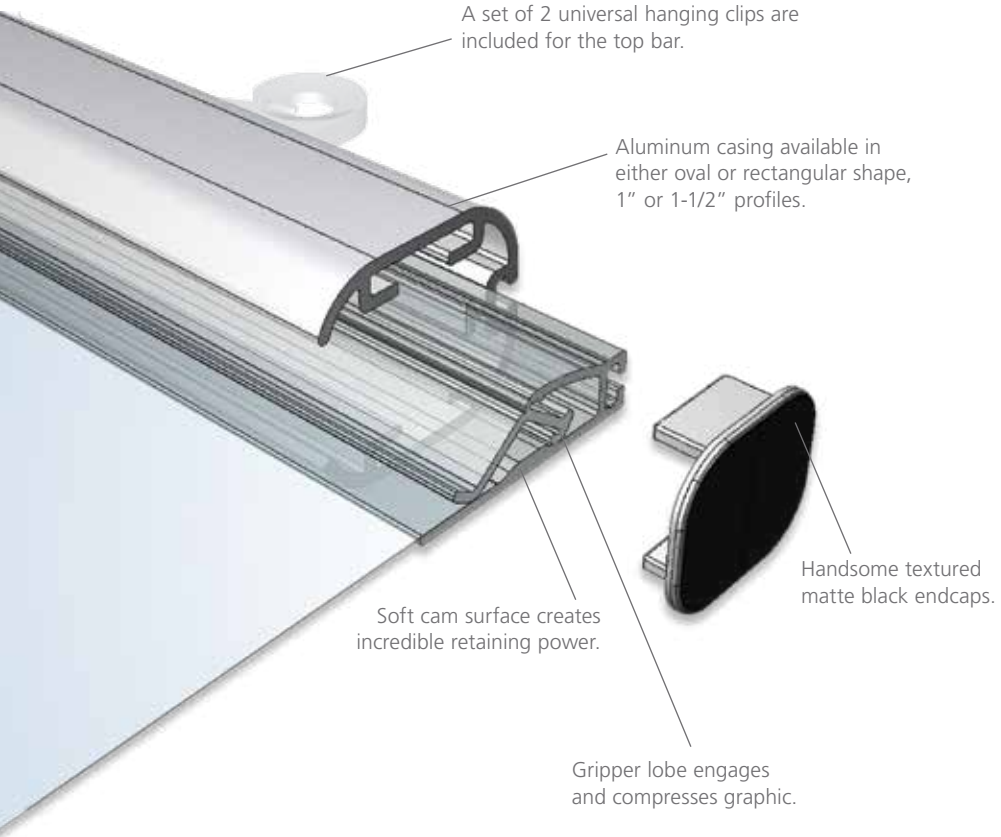

SN1



Gripper extends below 1" w x 1" h cases



SN2

Grip Graphics up to 70 mil (.070") thick.

SN3



Extended 1" w x 1-1/2" h cases totally enclose gripper



SN4

Accessories:

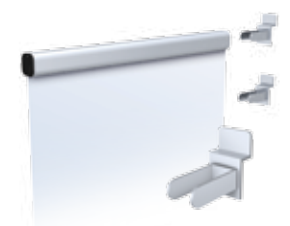

UCSWB
For slatwall
set of 2 for 36" max.
Mounts perpendicular to wall.

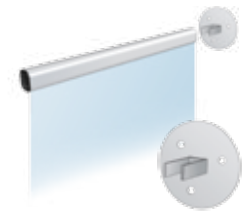

UCWB
Wall Mount Bracket - set of 2,
3-1/4" diameter. For 36" maximum.
Indicate **-B** Black or **-S** Silver



Stands featuring SnapGraphics™ Bars are available.

Slimline SnapGraphic™



Grip Graphics up to 50 mil (.050") thick.



Ingenious gripper snaps closed after graphic insertion with incredible strength, torque and care.

Patented!

U.S. Utility Patent # 6,637,716
U.S. Design Patent # D-424,120

- Beautifully finished aluminum case
- No graphic end treatment required



SOLD AS A KIT
Top & bottom crossbar with 2 universal hanging clips.

Specify: Case—Length—Color*

Case

SN5 Rectangular, 1-1/2" high

Length

1 - 18"	4 - 28"	7 - 60"
2 - 22"	5 - 36"	8 - 72"
3 - 24"	6 - 48"	9 - 96"

Custom lengths available

Color*

-S	Satin Silver
-B	Matte Black

*Does not affect price, but must use to order.



UC180
Steel Brackets
Set of 4. Allows casings to be joined in series.



Aluminum Casing
5/8" w x 1-1/2" h. Encloses gripper.

SNAPGRAPHICS™

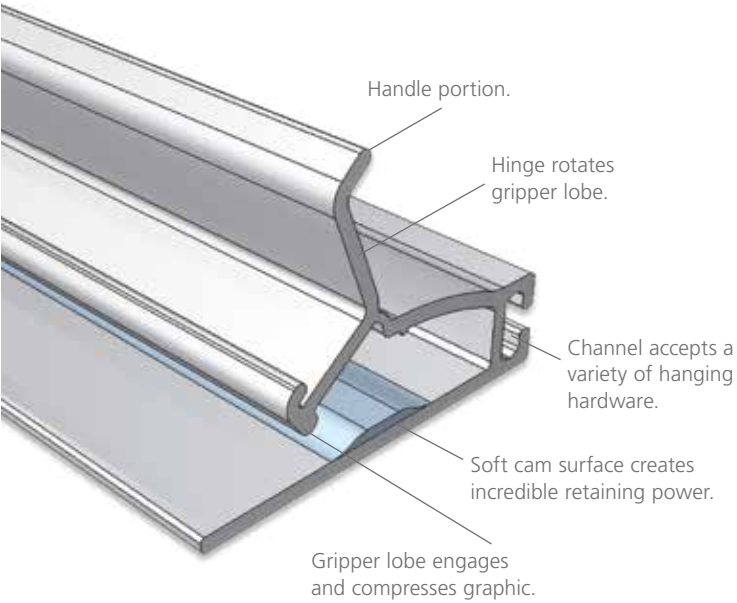

Ingenious grippers snap closed after graphic insertion with incredible strength, torque and care.

- Closes easily once graphic is inserted
- No pockets or graphic end treatment required
- Ideal for large signage. Units are reusable
- U.S. Utility Patent # 6,637,716
U.S. Design Patent # D-424,120
- Grip graphics to .70 mil (.070") thick.

Snapgraphics™	Snapgraphics Oval™	Length
GC18	GCO18	18"
GC22	GCO22	22"
GC24	GCO24	24"
GC28	GCO28	28"
GC36	GCO36	36"
GC48	GCO48	48"
GC60	GCO60	60"
GC72	GCO72	72"
GC96	GCO96	96"

Custom lengths available.

SNAPGRAPHICS OVAL™

Same fabulous gripping power, but rounded body offers more rigidity & strength.



SOLD AS A KIT

Top & bottom crossbar with 2 universal hanging clips.



GC

- C Clear blends beautifully
- B Black not for direct sunlight
- S Silver simulates tech

GCO

- C Clear – See the full graphic
- S Silver – Simulates aluminum
Includes black end caps.

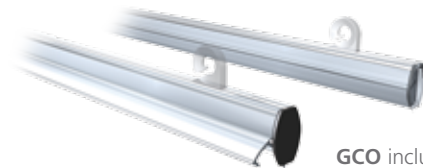

Wide variety of hanging holders available.

EasyGraphics Grippers™



Grip Graphics up to 3/32" (.093") thick.

Hanging system features phenomenal performance with the convenience of instant graphic insertion.
Only good for rigid media

- Beautiful aluminum case
- No pockets or graphic end treatment required
- Simply insert graphic
- Reusable, ideal for large signage



SOLD AS A KIT
Top & bottom crossbar with 2 universal hanging clips.

Specify: Case—Length—Color*

Case

EA1	Oval
EA2	Rectangular
EA3	Oval, long
EA4	Rectangular, long

Length

1 - 18"	4 - 28"	7 - 60"
2 - 22"	5 - 36"	8 - 72"
3 - 24"	6 - 48"	9 - 96"

Custom lengths available

Color*

-S	Satin Silver
-B	Matte Black

*Does not affect price, but must use to order.



-AB Adhesive back models available. Same cost as models with hanging clips.

EA1



Gripper extends below 1" high profiles



EA2

EA3



Longer 1-1/2" models totally enclose gripper



EA4

Accessories:



UC44

Wall Mount Kit for EA1 & EA2 Set of 4.



UC180

Steel Brackets Set of 4. Allows casings to be joined in series.



UCSP

Aluminum Screw Posts, set of 2. For thick graphics (up to 3/8"), use in place of gripper.



UCSWB

For slatwall set of 2 for 36" max. Mounts perpendicular to wall.

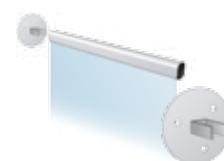

UCWB

Wall Mount Bracket - set of 2, 3-1/4" diameter. For 36" maximum. Indicate **-B** Black or **-S** Silver



Wide variety of hanging holders available.

EASYGRAPHICS™ EA Series

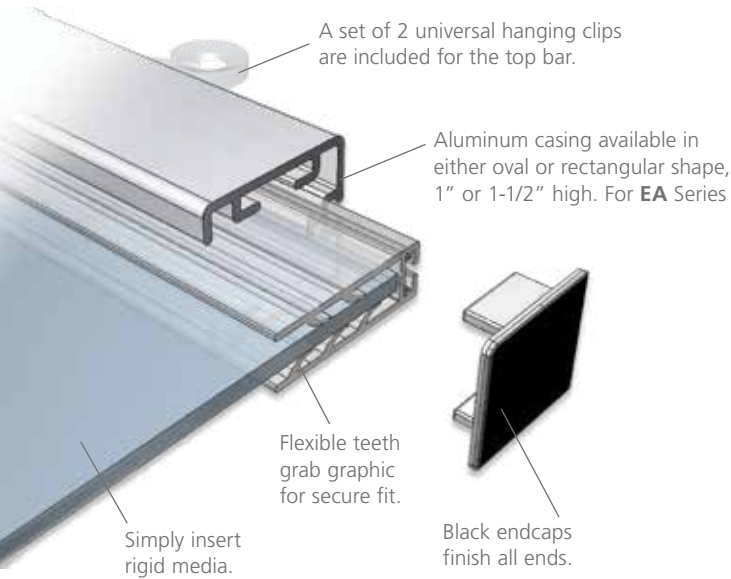

Easiest graphics gripper bar available.
Only good for rigid media.
Simply insert the graphic from the bottom up!



SOLD AS A KIT
Top & bottom crossbar with
2 universal hanging clips.

Easygraphics™	Length
GJ18	18"
GJ22	22"
GJ24	24"
GJ28	28"
GJ36	36"
GJ48	48"
GJ60	60"
GJ72	72"

Custom lengths available

GJ

- C Clear blends beautifully
- B Black not for direct sunlight
- W White is white
- S Silver simulates tech

Grip Graphics up to
1/8" (.125") thick.

EASYGRAPHICS™ GJ Series

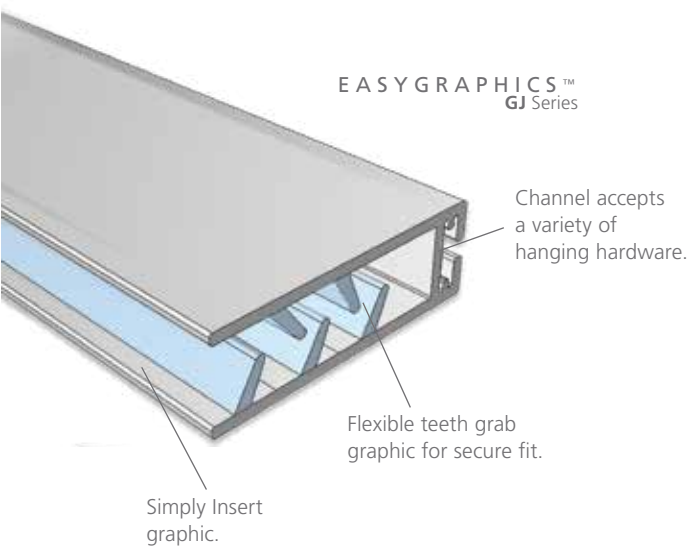

Common EA & GJ Accessories:



J180
Straight Split for joining
units side by side.



Wide variety of
hanging holders
available.



Hanging Trapeze Bars™



CUSTOM TRAPEZE BARS

Sizes, diameters, end caps can be customized.

SINGLE SECTION TRAPEZE BARS

Simply Hem Graphics top and bottom for aluminum tubes.

Features:

- Strong and lightweight
- Very easy to use
- Extremely economical
- Clear satin anodized finish
- Shipped one set per polybag

SOLD AS A TOP CROSSBAR AND BOTTOM CROSSBAR SET

Steel eyebolts are included for top crossbars.

Aluminum alloy tubes, etched and clear anodized finish.

SINGLE SECTION TRAPEZE BARS

Model	Banner Width	Diameter
BP01	18"	7/8"
BP02	22"	7/8"
BP03	24"	7/8"
BP04	28"	7/8"
BP05	36"	7/8"
BP06	48"	7/8"
BP07	60"	7/8"
BP08	72"	7/8"
BP011	84"	7/8"*
BP013	96"	7/8"*

*Has 3rd Eyebolt in center, banner notch required.

Standard Configuration

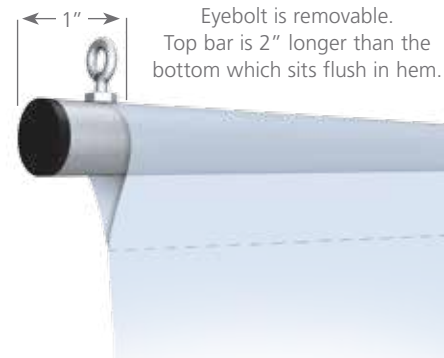

Optional Configuration

Specify: **SD** Side Eyebolts
Same cost as standard configuration.
Ordering Example: **BP06SD**

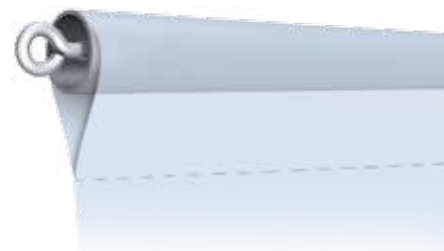

BABY TRAPEZE BAR WIRE SETS

3/16" diameter steel wire. Tops have loops at each end. Bottoms are straight cut.



Model	Width	Model	Width
BPW09	9"	BPW18	18"
BPW12	12"	BPW24	24"

MULTIPLE SECTION TRAPEZE BARS

Simply Hem Graphics
top and bottom for aluminum tubes.

- Strong and lightweight
- Very easy to use
- Extremely economical
- Clear satin anodized finish

SOLD AS A TOP CROSSBAR AND BOTTOM CROSSBAR SET

Steel eyebolts are included for top crossbars.

Standard Configuration

Top Bar is 2" longer than bottom bar, which sits flush inside bottom hem.

Optional Configuration

Specify: **SD** Side Eyebolts
Same cost as standard configuration.

Models	Banner Width	Sections	Diameter	# Eyebolts
BP09	96"	2	1-1/4"	3
BP10	120"	2	1-1/4"	3
BP12	144"	2	1-1/4"	3
BP15	180"	3	1-1/4"	4
BP20	240"	4	1-1/4"	5

CUSTOM SIZES AVAILABLE.

Disclaimer:

We recommend getting samples and fully testing these products for your application. Purchaser determines suitability of all product usage and assumes all risk & liability. Neither the seller nor the manufacturer shall be held liable for any injury, loss or damage from use of such product.



Multiple section units connect with
solid aluminum turned bushings.

Wall Mount Trapeze Bar™ Bracket Sets

WALL MOUNT BRACKET SETS

Wall mount bracket sets work in conjunction with our optional configuration **SD** Trapeze Bars, pages 84 & 85, ie. those with top bars having side threads.

Simply remove eyebolts from Trapeze Bars and discard (or order without). Brackets attach to top bar only, bottom bar drops freely.



BPSB1 - For single section Trapeze Bars (7/8" diameter).

BPMB1 - For 2 section Trapeze Bars **BP09SD**, **BP10SD** & **BP12SD**.

BPMB2 - For 3 section Trapeze Bars **BP15SD**.

BPMB3 - For 4 section Trapeze Bars **BP20SD**.

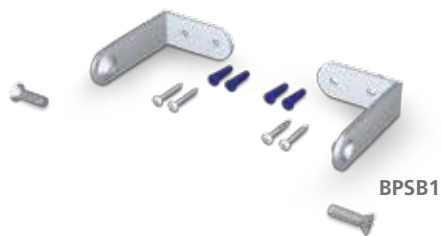

BPSB1

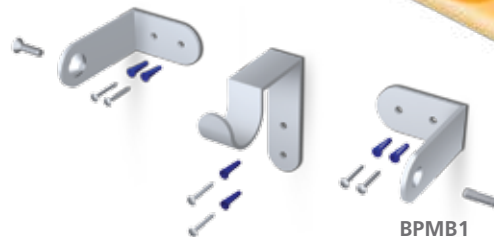

BPMB1

SIMPLE GRAPHIC HANGING SOLUTIONS!

GRAPHIC CHANGEOUTS WITHOUT A LADDER



Combining Trapeze Bars & SnapGraphic Grippers.
Facilitate graphic changes to be extremely associate friendly.
Extremely cost efficient, layouts are offered on a project basis.

Telescopic Changeout Pole

- JBT1** Two sections - opens - 10' Extension / 15' Ceiling.
- JBT2** Three sections - opens - 15' Extension / 20' Ceiling.

Hanging Banner Kits

HANGING DOWEL KITS

Includes: (2) aluminum 1/2" diameter dowels, end caps and (1) diamond braided cord. Use banners with a hem top & bottom, put nail into wall and you're good to go.

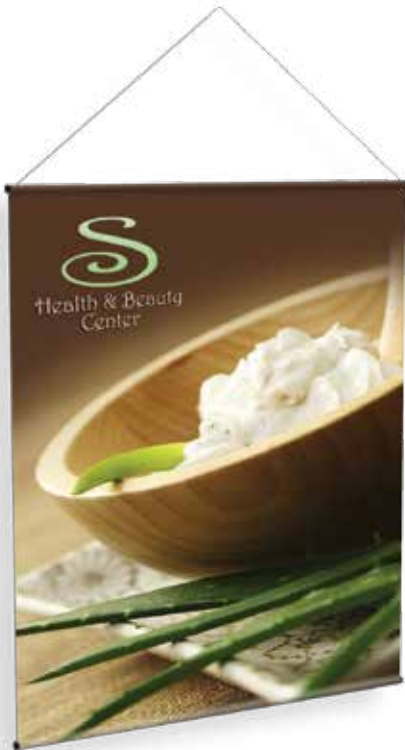

Choose Model and Color*

PP24	24" wide dowels
PP36	36" wide dowels
PP48	48" wide dowels

WALL MOUNT SNAPBAR KITS

Includes: (2) Aluminum Snap Bars, matte anodized finish. Strong springs hold graphics to 1/16" thick. Black endcaps (4) wall screws & anchors.



Choose Model and Color*

MEB1	18"	MEB5	36"
MEB2	22"	MEB6	48"
MEB3	24"	MEB7	60"
MEB4	28"	MEB8	72"

-S Satin Silver **-B** Matte Black

WALL MOUNT BANNER KITS

Includes: (2) 3/4" diameter matte anodized poles and (2) 3-1/4" round plates with mounting holes. Wall hardware not included.



Choose Model and Color*

WB1	12" Banner Width
WB2	18" Banner Width
WB3	22" Banner Width
WB4	24" Banner Width
WB5	30" Banner Width

*Does not affect price, but must use to order.

Visual Merchandising Clamps™

SOLID ALUMINUM SIGNING CLAMPS

- Solid aluminum alloy
- 2" w x 3" h, rubber grips
- Anodized satin finishes
- Clever binder spring
- Grip range up to 1/2" thick.

Specify: **-S** Satin Silver **-B** Matte Black



VCDP



VCWM

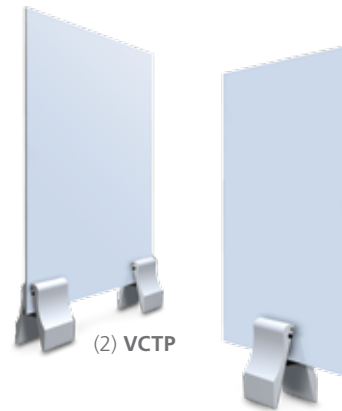

(2) VCTP



VCCD



VCDP

Steel grid clip, telescopic aluminum tube assembly 20"-36"



VCTP

Clamp only, use on table top, or for small signs.



VCSW

Clamp with integral slot wall bracket included.



VCCO

360° swivel, snaps onto poles, Diameter: 1" -1, 1-1/2" -3, 3/4" -5, 1-1/4" -7.



VCCD

Clamp has integral eye hook for ceiling drops.



VCMT

Clamp with male 1/4-20 thread, multifunctional.



VCWM

Features hole for mounting parallel on a wall.

Ceiling Anchors, Links & Cables

Ceiling Anchors

Swivel Clip

Clear plastic clip for ceiling grids, swivels 360°. Sold 10/per. **ANC01.**



Metal Threaded Studs

Strong heavy duty scissors clip. Use to mount threaded accessories. Sold 10/per. **ANC14.**



Grid Snap On Swivel Hook

1/4" hook slot rotates 360°. Sides simply snap on. White. Sold 10/per. **ANC02.**



Steel Spring Stud

Clips onto grid, thread for accessories. Sold 10/per. **ANC13.**



Grid Snap On Eye

3/8" diameter eye. Great looking. Simple & strong. Sold 10/per. **ANC03.**



Ceiling Twist Loop

7/8" loop, 2" base. Quick connect, just twist. White. Sold 10/per. **ANC06.**



Metal Loop

Strong steel spring. Provides 15/64" loop. Sold 10/per. **ANC04.**



Clear Hinged Hook

One piece hook hinges open & closes around ceiling grid. Sold 10/per. **ANC05.**



Suction Cups

Clear 2-14" diameter with hanging hook. Sold 100/per. **ANC18**



Suction Cup with push tack. Clear 2-1/4" diameter Sold 100/per. **ANC19**



Round Magnetic Bases

Plated steel case and hook house powerful magnets.



Model	O.D.	Rating
RMB1	1-1/2"	18 lbs.
RMB2	2"	20 lbs.
RMB3	2-1/2"	38 lbs.

Links

Links Sold 100/per.

- CLK1** C Link 1-1/12" long
- CLK2** C Link 3" long
- SHK1** S Link 1" long
- SHK2** S Link 1-5/8" long



Rings

- Set of 4, hold graphics with holes or grommets.
- RG3** 2" Diameter
- RG5** 3" Diameter



Double C Hooks

Plated steel hangwires. Economical. Holds up to 10 lbs. Sold 50/per.

Order: **HDC4, HDC6, HDC12**, etc.

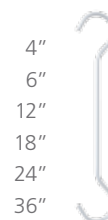

Double Loop Cable

1/32" uncoated stainless steel with 1/2" long loops. Hold up to 50 lbs. Sold 2/per.

HDL6 6" **HDL12** 12"

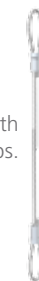

Adjustable Cable Assemblies

Wire rope loop one side, straight wire other, plus an adjustable spring loaded cable lock. Choice of locks - Diecast zinc and double barrel steel. Simply feed cable through the lock and adjust to required length. Sold 2/per.

Model	Lock	Gauge	Length	Rating
ADC136	Diecast	1/32"	6'	14 lbs.
ADC1312	Diecast	1/32"	12'	14 lbs.
ADC1318	Diecast	1/32"	18'	14 lbs.
ADC166	Diecast	1/16"	6'	50 lbs.
ADC1612	Diecast	1/16"	12'	50 lbs.
ADC1618	Diecast	1/16"	18'	50 lbs.
ABS166	Steel	1/16"	6'	50 lbs.
ABS1612	Steel	1/16"	12'	50 lbs.
ABS1618	Steel	1/16"	18'	50 lbs.



Adjustable Cable Locks (without cable)

Use with bare **uncoated** wire rope only.

ADC13	Diecast	1/32"
ADC16	Diecast	1/16"
ABS16	Steel	1/16"



Diecast Lock



Steel Lock

Mounts, Cable, Harnesses & Tapes

Snap-on Graphic Clips (2/set)
Holds rigid media up to 3/32" thick.

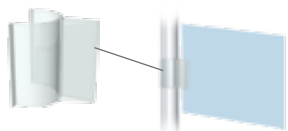

- HT1** Fits 1" diam. uprights
- HT2** Fits 3/4" diam. uprights
- HT3** Fits 1-1/2" diam. & SignPost

French Cleat

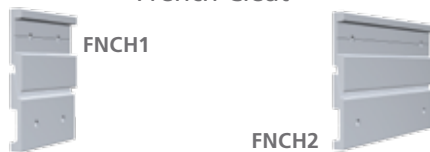

Set of 2 interlocking French Cleats. 4 screws & wall anchors included. Anchor 1 piece to wall other to object.

- | | |
|-----------------|------------------|
| FNCH1 2" | FNCH3 12" |
| FNCH2 4" | FNCH4 22" |

Grid Ceiling Divider



GRCD1 for positioning anchors & signage in the best possible location. 24" long, white, compatible for most grid ceilings.

Ceiling Tracks



White aluminum bars with mounting holes. Mounting hardware not included. **CTK48** 48", 3 holes, **CTK96** 96", 5 holes.

Harness Sets

Harness Sets should be professionally installed.

- HRNS3** 3 small shackles, 3 double loop lead wires (specify length), collection shackle, 20' pendant wire, 2 wire rope clips.
- HRNS4** 4 small shackles, 4 double loop lead wires (specify length), collection shackle, 20' pendant wire, 2 wire rope clips.
- HRNS5** 5 small shackles, 5 double loop lead wires (specify length), collection shackle, 20' pendant wire, 2 wire rope clips.



Forged eyebolts, shackles, quick links, aircraft cable.

Fully test every installation as conditions vary, and neither the manufacturer nor the sales representative may be held liable for injury or loss or damage resulting from the use of these products.

Wire Rope Aircraft quality galvanized. 100' rolls.

Model	Gauge	Style	Rated
HWB32100	1/32"	Bare Uncoated	14 lb.
HWB16100	1/16"	Bare Uncoated	50 lb.



Uncoated
HWB32100 100'

- DWSC132** Oval crimp sleeves. For 1/32" 50/per.
- DWSC116** Oval crimp sleeves. For 1/16" 50/per.



CTWBC Crimping tool.

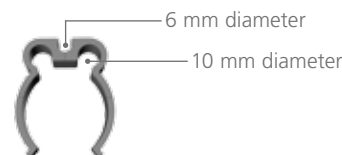

Wire Management Clips

Holds 6mm & 10mm cables. (set of 4).

- CRWO** for 1" to 1-1/2" tubes
- CRWM** for SignPost & Creo

Flexible Magnet



Flexible magnet 1" wide 3/32" thick high tack adhesive. 100' roll. **MGT2**.

Magnetic Receptive Tape



OGMRS - Magnetic receptive tape .025" x 1" 100 feet with pressure sensitive adhesive.

Two-sided Removable Tape



Roll of white foam tape with removable adhesive on 2 sides. 1/32" thick, 1" wide, 30' long. **GXTP1**

Removable Foam Strips



White, each strip is 1/2" x 2" long and each has a load capacity of 3 lbs. Pull tab sideways to remove. Packed 36. **RFT1**

Straight Flat Walls

PILLOWCASE MOUNTING

Features:

- Durable construction
- Strong, yet lightweight
- Satin anodized aluminum
- Designed for pillowcase mounting
- Quick easy assembly
- Sectional crossbars - uprights
- Heavy 9 lb. steel bases
- 1-1/4" diameter tubing
- Slightly radiused corners

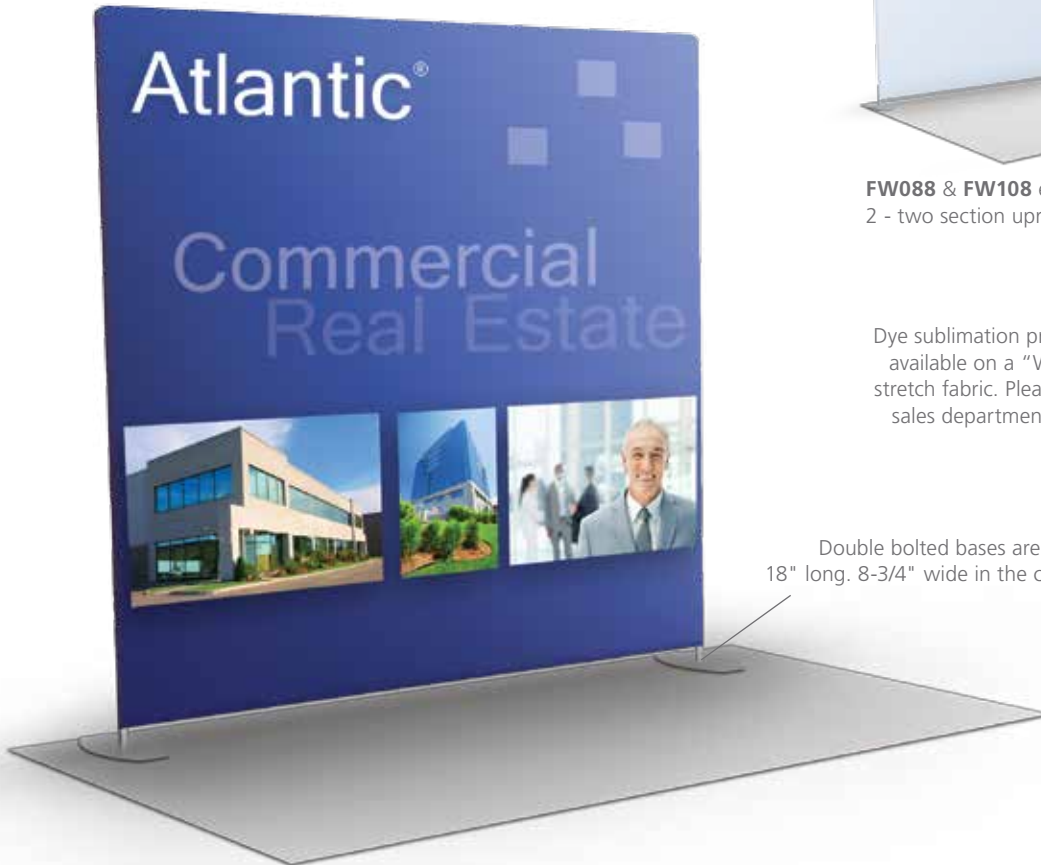

Double bolted bases are 18" long, 8-3/4" wide in the center.

TOOL - FREE ASSEMBLY

LIGHTWEIGHT, STRONG AND PORTABLE

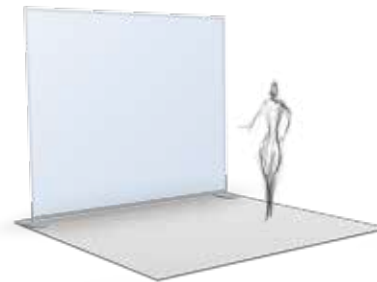

FW088 & FW108 each have 2 bases and 2 - two section uprights & crossbars.

Dye sublimation printed graphics available on a "Wrinkle Free" stretch fabric. Please contact our sales department for pricing.

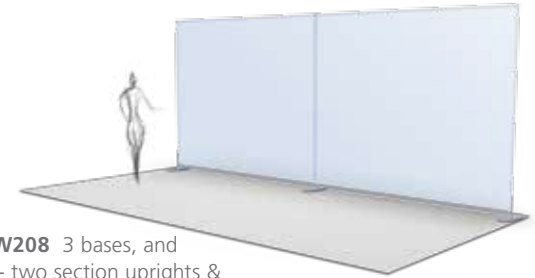

FW208 3 bases, and 4 - two section uprights & 4 - two section crossbars.

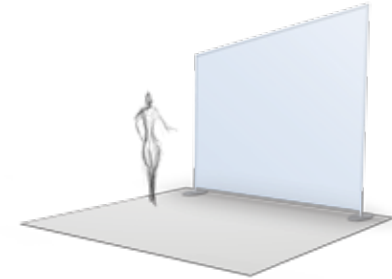

Sloped versions available on a custom basis.

Model	Nominal	Graphic Size
FW088	8' wide x 8' high	96" w x 96" h
FW108	10' wide x 8' high	111" w x 96" h
FW208	20' wide x 8' high	230" w x 96" h

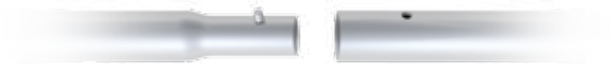

Swage & Spring Button, Tool-Free Assembly



SNB-1 Duffle style bag 33" x 12" x 13". Inexpensive and perfect for carrying unit, and keeping all the components together.

FABRIC DISPLAYS ARE IMPACTFUL!

PILLOWCASE MOUNTING



TOOL - FREE ASSEMBLY

Frame Structures

- 1" constant diameter clear anodized uprights. Sleek design, tubes feature swaged and button construction for quick assembly & portability.
- Laser cut bases lend stability. Double bolted 18" long, 8-3/4" wide in the center.
- Hanging units without bases, with eyebolts are available - contact our friendly sales staff.

Frames	w'	h'	Frames	w'	h'
VG62	2'	6'	VG82	2'	8'
VG63	3'	6'	VG83	3'	8'
VG64	4'	6'	VG84	4'	8'



Swage & Spring Button, Tool-Free Assembly

LIGHTWEIGHT & PORTABLE



Dye Sub Fabric Graphics

- Endless possibilities, custom printed from your artwork, fabulous for visual marketing.
- These pillowcase mount graphics feature an industrial bottom zippered closure for easy assembly.
- Graphics are available 1 sided & 2 sided. See graphic specifications. Light blockers are also available.
- High Impact 720 dpi dye sub printing on a virtually "Wrinkle Free" stretch fabric, One-sided graphics have an opaque backing.



You may also like our [Harmony Banner Stands](#) on pages 124-125.

Classic Graphic Headboards



Pillowcase mounted graphics are beautiful and cost effective.

Fabric graphics can be coordinated with mattress and bedding designs.

Our specialty: Fabrication of custom aluminum frames.

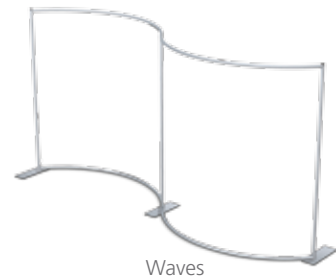
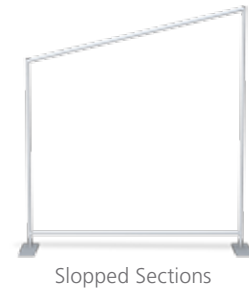

Classic Graphic Headboards

- Designed for pillowcase graphics
- Ships cost efficiently-small carton
- 1" diameter aluminum alloy
- Assembles easily in 5 minutes
- Satin anodized finish
- Height of all units 60"

Model	Width
HB39LS	39" Twin
HB54LS	54" Full
HB60LS	60" Queen
HB72LS	72" California King
HB76LS	76" King



Crest Graphic Headboards

Crest Graphic Headboards

- Use pillowcase graphics
- 1-1/4" diameter alloy aluminum
- Satin anodized finish
- Height of all units 72"
- Ships KD in a small carton
- Amazingly easy to assemble

Model	Width
HB39CR	39" Twin
HB54CR	54" Full
HB60CR	60" Queen
HB72CR	72" California King
HB76CR	76" King

CUSTOM SIZES & MODELS AVAILABLE.

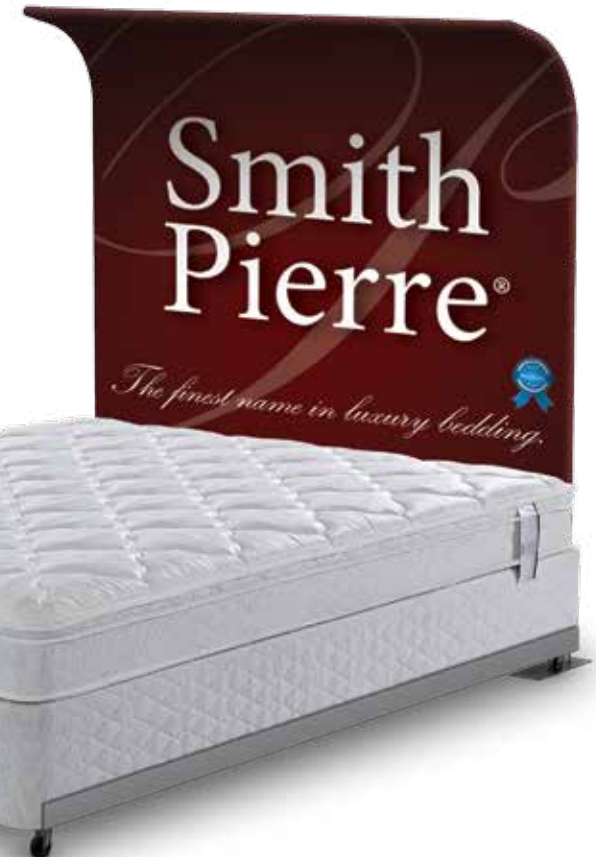

Inner support bushing ensures the structural integrity of the 4" x 18" steel base.

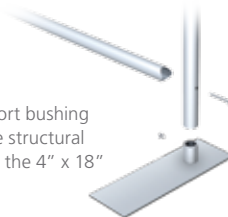

CURVED TOPS ADD EXTRA FOCUS

Cobra and Crescent Stands™

SPACE DEFINERS ENHANCE BRAND AWARENESS!



Uniquely shaped freestanding structures, Cobra and Crescent Stands™ deliver your brand message in impressive style.

- 1" diameter aluminum anodized structure
- Easy 5 minute assembly
- 7' height - 3 widths

Frame Structures

- Lightweight, portable and sturdy, 1" diameter clear anodized tubing made to exacting specifications.
- Extremely easy to set-up and use. Assemble in minutes with coded indicators.

Cobra	Width
CBR2	24"
CBR3	36"
CBR4	48"

140" Approximate Linear Length.

Crescent	Width
CENT2	24"
CENT3	36"
CENT4	48"

91-1/4" Approximate Linear Length.

Note: Due to the complexities of the radii, and because fabrics & sewing techniques vary, please order the frame before graphic preparation.



Accessory Bag **EBP-4** holds any size Cobra or Crescent Stand.



Tension Fabric Graphics

- Endless possibilities, custom printed from your artwork, fabulous for visual marketing.
- Graphics are available 1 sided & 2 sided. See graphic specifications. Light blockers are also available.
- Pillow case mounting with an industrial zipper closure offers amazing ease of assembly.
- Top quality 720 dpi dye sub printing on a virtually "Wrinkle Free" stretch fabric, designed for this application.

MEGA WAVE FRAME STRUCTURES FEATURE TOOL-FREE ASSEMBLY!!

Lightweight portable and sturdy, frames are constructed of 1-1/4" diameter clear anodized tubing made to exacting specifications. A soft travel bag is included with every frame. Extremely easy to set-up and use. Assemble in minutes with color-coded indicators. Hanging units are available with eyebolts.

Frames	Width		Height	Depth
MG84	8'	117" Approximate Linear Length	4'	17"
MG86	8'		6'	17"
MG88	8'		8'	17"
MG810	8'		10'	17"

MG104	10'	140" Approximate Linear Length	4'	18"
MG106	10'		6'	18"
MG108	10'		8'	18"
MG1010	10'		10'	18"

MG124	12'	155" Approximate Linear Length	4'	20"
MG126	12'		6'	20"
MG128	12'		8'	20"
MG1210	12'		10'	20"

Note: Fabrics differ as do sewing techniques, please order the frame before graphic preparation.



SNB1

SNB1 (imported): Soft nylon bag keeps elements together, **FREE** with every Mega Wave Wall. 33" x 12" x 13".

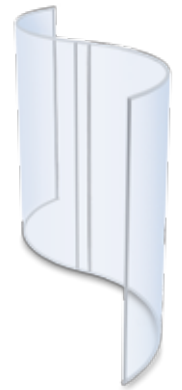

Swage & Spring Button,
Tool-Free Assembly

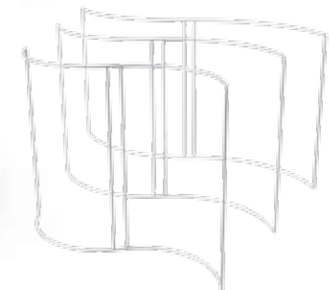

Mega Wave Tension Graphics

- Endless possibilities, custom printed from your artwork.
- Top quality 720 dpi dye sub printing on a virtually "Wrinkle Free" stretch fabric, designed for this application.
- Produce fabulous visual marketing effects.
- Pillow case mounting with an industrial zipper closure offers amazing ease of assembly.
- Graphics are available 1 sided & 2 sided. Light blockers are also available.

Cool C Walls™

ENHANCE BRAND AWARENESS!

- Lightweight portable and sturdy
- Assemble in minutes with coded indicators
- 1-1/4" diameter anodized aluminum
- Soft travel bag included
- All Made in the U.S.A.



Swage & Spring Button, Tool-Free Assembly



TOOL - FREE ASSEMBLY!

Center pole offers support.

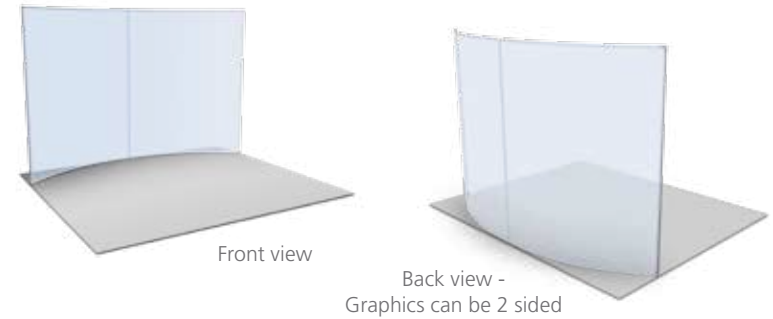

Front view

Back view -
Graphics can be 2 sided

Frame Structures

Frames	Width	Height	Depth
CC86	96"	120"	6' 30"
CC88	96"	Approximate	8' 30"
CC810	96"	Linear Length	10' 30"
CC106	117"	140"	6' 33"
CC108	117"	Approximate	8' 33"
CC1010	117"	Linear Length	10' 33"
CC126	144"	176"	6' 42"
CC128	144"	Approximate	8' 42"
CC1210	144"	Linear Length	10' 42"

As sewing techniques differ, please order the frame before graphic preparation.

Graphics available - call for pricing.



SNB1 (imported): Soft nylon bag keeps elements together, **FREE** with every Cool C Wall. 33" x 12" x 13".

Table Top Tension Fabric Displays

TOOL - FREE SET UP!
DESIGNED FOR PILLOWCASE GRAPHICS.

Straight Across



Curved, 17" Deep



UNITS SHOWN ON 6' TABLES, ALSO WELL SUITED FOR 8' TABLES.

Straight Models: 69" wide, includes 2 round 6-3/4" bases.

TBS3	36" high
TBS4	48" high
EBGH	Accessory Bag

- Affordable, portable
- Quick, tool-free assembly

- Designed for pillowcase graphics
- Lightweight, strong aluminum frames



Swage & Spring Button, Tool-Free Assembly

Curved Models: 69" wide, 17" deep, 80-5/8" Lineal Length.

TBC693	36" high
TBC694	48" high
EBGH	Accessory Bag

- Sturdy center pole ensures support
- Gently radiused corners

Halos™

HALO STRUCTURES

- 1-1/4" diameter aluminum tubing
- Easy swage & spring button assembly
- Satin anodized finish
- Metal eyebolts for hanging



Swage & Spring Button Construction

Shown below with graphics and harness sets - sold separately.
Custom sizes available.



HALO12 with HRNS5 harness

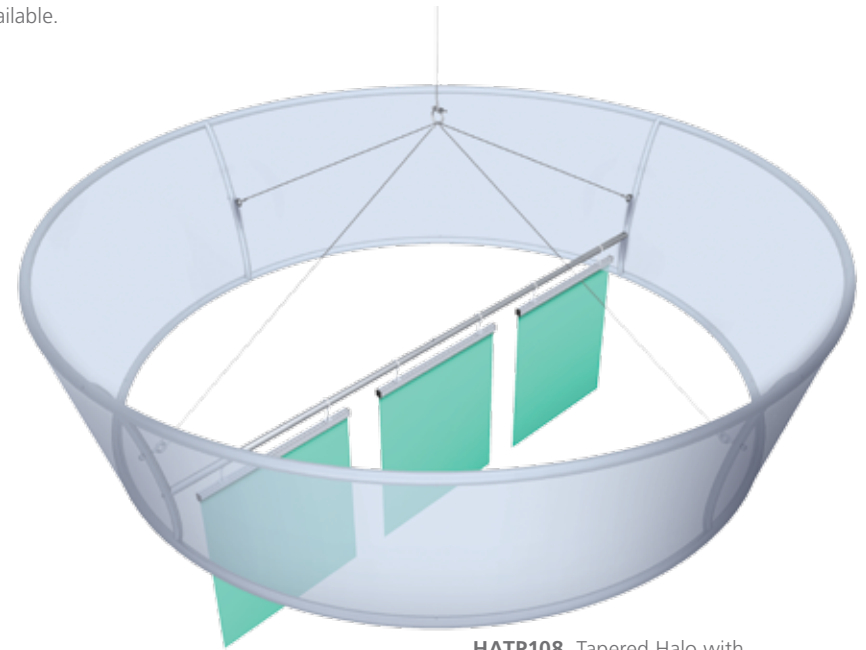

HATP108 Tapered Halo with HRNS4 Harness Set & custom Trapeze/Gripper Bar set.

Halos Equal in Diameter Top & Bottom

Model	Size	Height	Sections	Struts	Accessory Harness Set
HALO6	6' Diameter	2-1/2'	4	3	HRNS3
HALO8	8' Diameter	3-1/2'	5	4	HRNS4
HALO10	10' Diameter	3-1/2'	6	4	HRNS4
HALO12	12' Diameter	3-1/2'	7	5	HRNS5



Forged Eyebolts included with Halo Structures. Harness sets sold separately.

Tapered Halos Larger Diameter Tops, Smaller Bottoms

Model	Size	Height	Sections	Struts	Accessory Harness Set
HATP64	6' Top, 4' Bottom	2-1/2'	4	3	HRNS3
HATP86	8' Top, 6' Bottom	3-1/2'	5	4	HRNS4
HATP108	10' Top, 8' Bottom	3-1/2'	6	4	HRNS4
HATP1210	12' Top, 10' Bottom	3-1/2'	7	5	HRNS5

CIRCLE MOONS

- Strong aluminum alloy tubing
- Swage & spring button assembly
- Satin anodized finish
- Metal eyebolts for hanging

	Diameter	Gauge	# of Sections
MOON4	4'	1"	3
MOON5	5'	1"	3
MOON6	6'	1-1/4"	4

	Diameter	Gauge	# of Sections
MOON8	8'	1-1/4"	5
MOON10	10'	1-1/4"	6
MOON12	12'	1-1/4"	7

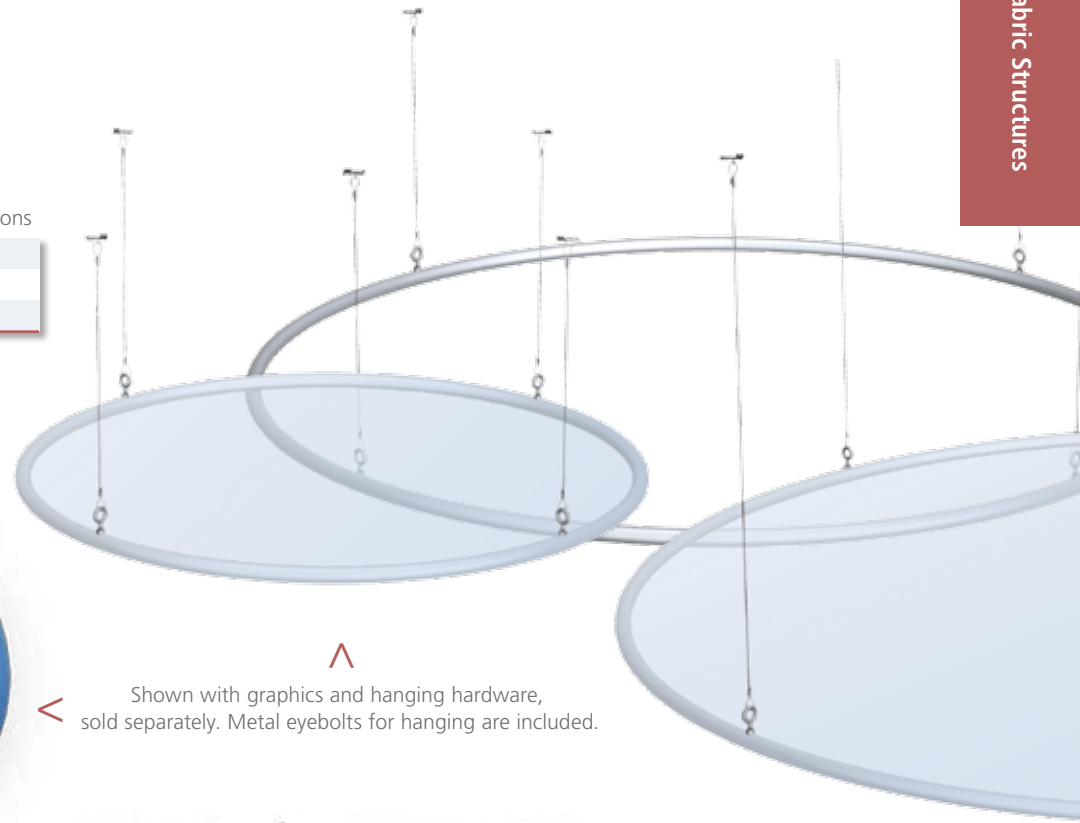

Shown with graphics and hanging hardware, sold separately. Metal eyebolts for hanging are included.



Swage & Spring Button Construction

FOR HALO STRUCTURES WE RECOMMEND HARNESS SETS

HRNS3 3 small shackles, 3 double loop lead wires (specify length), collection shackle, 20' pendant wire, 2 wire rope clips.

HRNS4 4 small shackles, 4 double loop lead wires (specify length), collection shackle, 20' pendant wire, 2 wire rope clips.

HRNS5 5 small shackles, 5 double loop lead wires (specify length), collection shackle, 20' pendant wire, 2 wire rope clips.

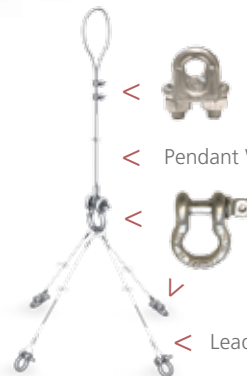

Forged wire rope clips for creating desired size top loops. Use 2 to insure safety.

Pendant Wire

Large forged collection shackle and smaller forged shackles that attach to eyebolts.

Lead Wires



FOR CIRCLE MOONS

Because these structures are lightweight, we recommend using Double C Hooks and anchors to attach to ceiling. Found on pages 90-91.

For added safety, Use harnesses.

Fully test every installation as conditions vary, and neither the manufacturer nor the sales representative may be held liable for injury or loss or damage resulting from the use of these products.

Halo Rails™

INNOVATIVE

BEAUTIFUL

ECONOMICAL



Fabric: Hemmed Graphics

Fabric graphics hang via pole pockets and plastic dowels top and bottom, which we supply.



HRPD - Extra plastic dowels 50' (for hemmed graphics)

Styrene Graphics

Styrene graphics hang from stapled soft plastic extrusions top and bottom.



HRSX - Extra plastic extrusions 50' (for styrene graphics)

Extra Graphic Holders

HALORAIL HALO KITS

Sold as a set
Top & bottom profiles, graphic holders, steel eyebolts.

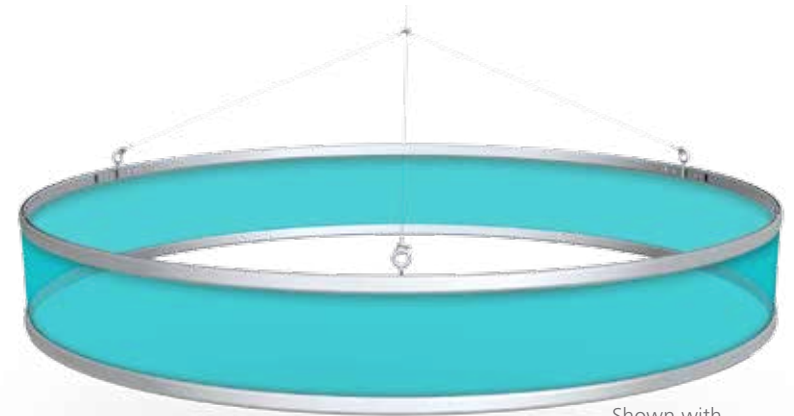

Shown with
Harness set, not included.

Features:

- Curved satin aluminum profiles handsomely house pole pocket graphics
- Strong, yet lightweight
- Height is equal to graphic height
- Ships ready for very easy assembly. Eyebolts come already attached.
- Quick graphic changeouts
- No costly vertical struts needed

HALORAIL HALO KITS

Diameter	Fabric, Hemmed Graphics	Styrene Graphics
6'	HRFK6	HRSK6
8'	HRFK8	HRSK8
10'	HRFK10	HRSK10
12'	HRFK12	HRSK12



Styrene graphics are stapled to plastic extrusions top and bottom. Swingline® Optima® 70 Desk Stapler, available at your local office supply supercenter.

HALORAIL FREEFORMS

Simple curves or elaborate FreeForms are all possible. Price is a function of quantity. Our engineering and sales team can work with your designers and price accordingly.



Minimum quantities & radius restrictions apply to above designs.

Horizon Pillowcase™

EASY TOOL - FREE ASSEMBLY



- Designed for pillowcase graphics
- Swage and spring button construction
- Eyebolts on top of units
- Satin anodized aluminum tubing

CUSTOM SIZES
AVAILABLE

Rectangles 1-1/4" tubing

Model	H x W x D (O.D.)
HPR3648	24" x 48" x 36"
HPR4248	24" x 48" x 42"
HPR3660	24" x 60" x 36"
HPR4260	24" x 60" x 42"

Cubes 1-1/4" tubing

Model	H x W x D (O.D.)
HPC18	18" x 18" x 18"
HPC24	24" x 24" x 24"
HPC30	30" x 30" x 30"
HPC36	36" x 36" x 36"

Triangles 1" tubing

Model	H x W (O.D.)
HPT36	18" x 36"
HPT42	24" x 42"
HPT48	24" x 48"
HPT60	30" x 60"

Swage & Spring Button Construction

Cross pieces can be any length, therefore custom sizes are available.



Hanging Eyebolts

Metal eyebolts are included at top of units.



Hanging Harness Sets Available



HORIZON PILLOWCASE TOWERS

- Designed for pillowcase graphics
- Easy tool-free assembly
- Swage and spring button construction
- Satin anodized aluminum tubing



TOOL-FREE
SWAGE & SPRING BUTTON CONSTRUCTION!



CUSTOM SIZES
AVAILABLE

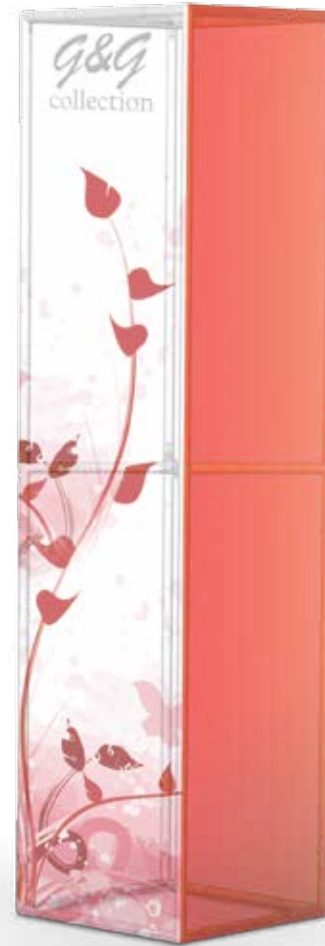

Model	Shape	Size	Tube Diam.	Crossbar
HPWT2472	Tri	24" x 72"	1"	No
HPWT3072	Tri	30" x 72"	1"	No
HPWR2472	Square	24" x 72"	1-1/4"	Yes
HPWR3072	Square	30" x 72"	1-1/4"	Yes

Collage Pop-Ups™

EXTRAORDINARY 3D GRAPHIC EFFECTS



Complete Collage Kit **43K1**

A CLEVER NONTRADITIONAL POP-UP

- Create 3D effects
- Incredibly eye-catching
- Lightweight aluminum
- Infinite configurations
- Instant set-up - take down
- Padded Roller Bag included

Pick - a - Kit Ordering Made Simple!

90 Standard Kits to choose from, design and upload your graphics, and get ready to be amazed.

Consult your printer for exact graphic specifications.



Complete catalog with 100 designs at:
www.displayfolio.com/pdf/collage

Complete Kits include:
 Custom printed graphics,
 Frame & Padded Roller Bag.



INSTANT SET UP AND KNOCK DOWN

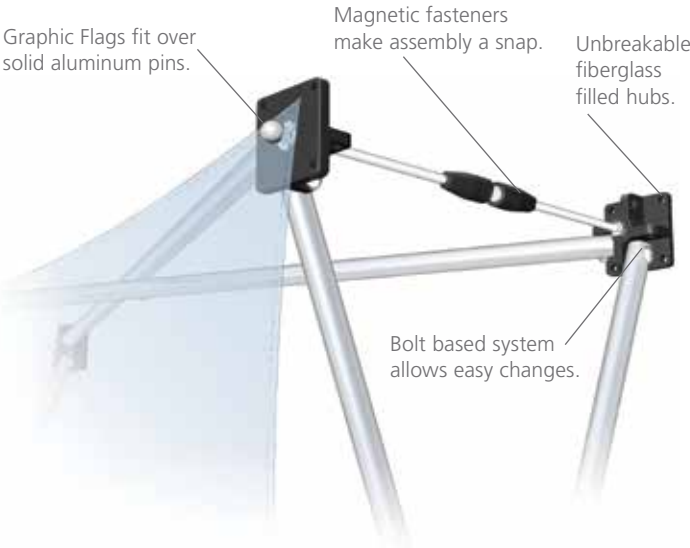

ENDLESS CREATIVE POSSIBILITIES



EIGHT STANDARD FRAME STRUCTURES

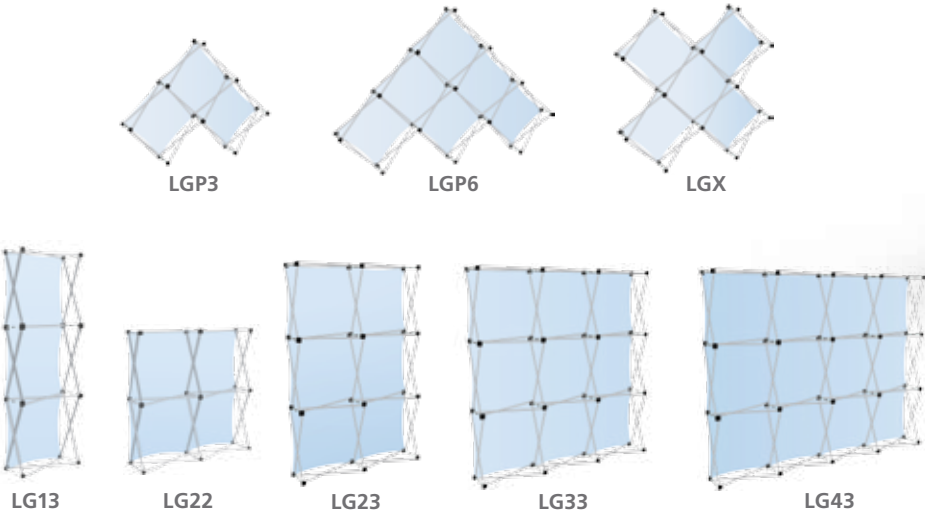

Complete Collage Kit 33K16

Collage Pop-Ups™

PICK - A - KIT ORDERING MADE SIMPLE!



- **43K Custom Kit**
 LG43 Frame
 2: CK Shelves
 6: CF1A
 1: CFF43

Choose from 90 standard layouts - or create your own.

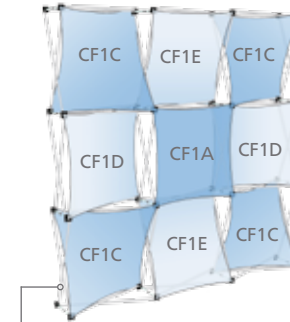

- **33K4 Kit**
 LG33 Frame
 1: CF1A
 4: CF1C
 2: CF1D
 2: CF1E

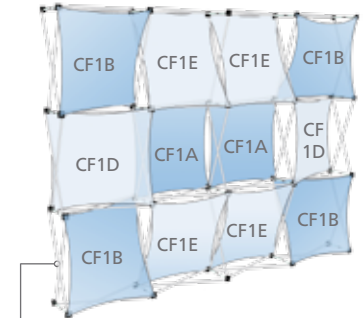

- **43K2 Kit**
 LG43 Frame
 2: CF1A
 4: CF1B
 2: CF1D
 4: CF1E



90 Standard Kits to choose from, design and upload your graphics, and get ready to be amazed.

Complete catalog available at:
www.displayfolio.com/pdf/collage

Consult your printer for exact graphic specifications.

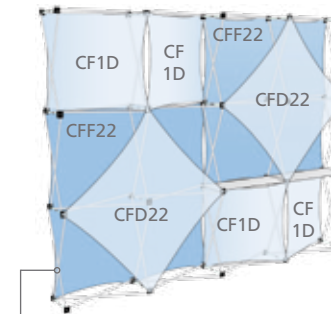

- **43K5 Kit**
 LG43 Frame
 2: CK Shelves
 2: CFF22
 2: CFD22
 4: CF1D

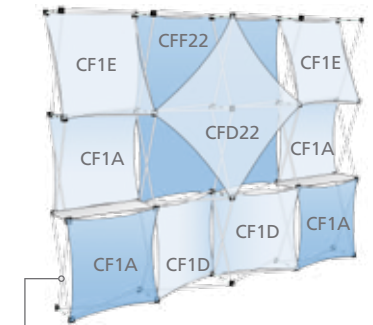

- **43K10 Kit**
 LG43 Frame
 2: CK Shelves
 1: CFF22
 1: CFD22
 4: CF1A
 2: CF1D
 2: CF1E

GRAPHICS

High impact 720 dpi Dye Sub Printing on a virtually "wrinkle free" stretch fabric, designed and engineered for this application.

EXTRAORDINARY 3D GRAPHIC EFFECTS!



13K1 Kit



13K12 Kit



23K1 Kit



P3K1 Kit



XK1 Kit



P6K10 Kit



Presto Pop-Ups™



PFK33 with GF33A graphic and (2) LEDPU lights.



Travel Bag included with every unit.

A VIRTUAL PORTABLE BILLBOARD

Frame Features:

- Graphic stays attached to frame in bag
- Hook perimeters included
- Incredibly easy, two minute set-up without tools
- Free oversized nylon carry bag with every frame
- Upgraded Portable Exhibit Cases available
- Ultra lightweight alloy tubes
- Matte satin anodized finish
- Adjustable leveling feet
- Bolt based system, add or subtract components

Available Configurations:

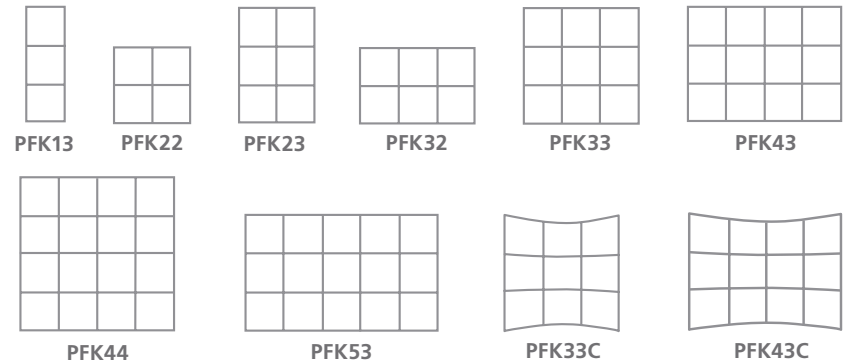

Frames

Model #	W x H	Wt. (lbs.)
PFK13	1 x 3 Quads	16
PFK22	2 x 2 Quads	17
PFK23	2 x 3 Quads	20
PFK32	3 x 2 Quads	20
PFK33	3 x 3 Quads	23
PFK43	4 x 3 Quads	31
PFK44	4 x 4 Quads	36
PFK53	5 x 3 Quads	36
	Curved	
PFK33C	3 x 3 Quads	25
PFK43C	4 x 3 Quads	31

Note: Each quad is approximately 30" x 30".

THE ULTIMATE IN PRESENTATION CONVENIENCE!

Our American made frame is the unsurpassed standard in Quality and Value.

These units "Pop-UP" and assemble in minutes. Graphics can stay attached to frame when closed.

Presto Pop-Up displays are ultra easy to set-up and the amazing quality dye sub graphic ensures maximum impact.

AMERICAN MADE VALUE AND RELIABILITY

Dye Sub Fabric Graphics

Regular		with End Panels	
GF13A	31" x 88.25"	GF13B	56" x 88.25"
GF22A	59.5" x 59.5"	GF22B	84.5" x 59.5"
GF23A	59.5" x 88.25"	GF23B	84.25" x 88.25"
GF32A	88.25" x 59.5"	GF32B	113.25" x 59.5"
GF33A	88.25" x 88.25"	GF33B	113.25" x 88.25"
GF43A	117.375" x 88.25"	GF43B	142.375" x 88.25"
GF44A	117" x 117"	GF44B	142" x 117"
GF53A	145.75" x 88.25"	GF53B	170.75" x 88.25"
Curved			
GF33AC	80" x 88.25"	GF33BC	105" x 88.25"
GF43AC	106" x 88.25"	GF43BC	131" x 88.25"

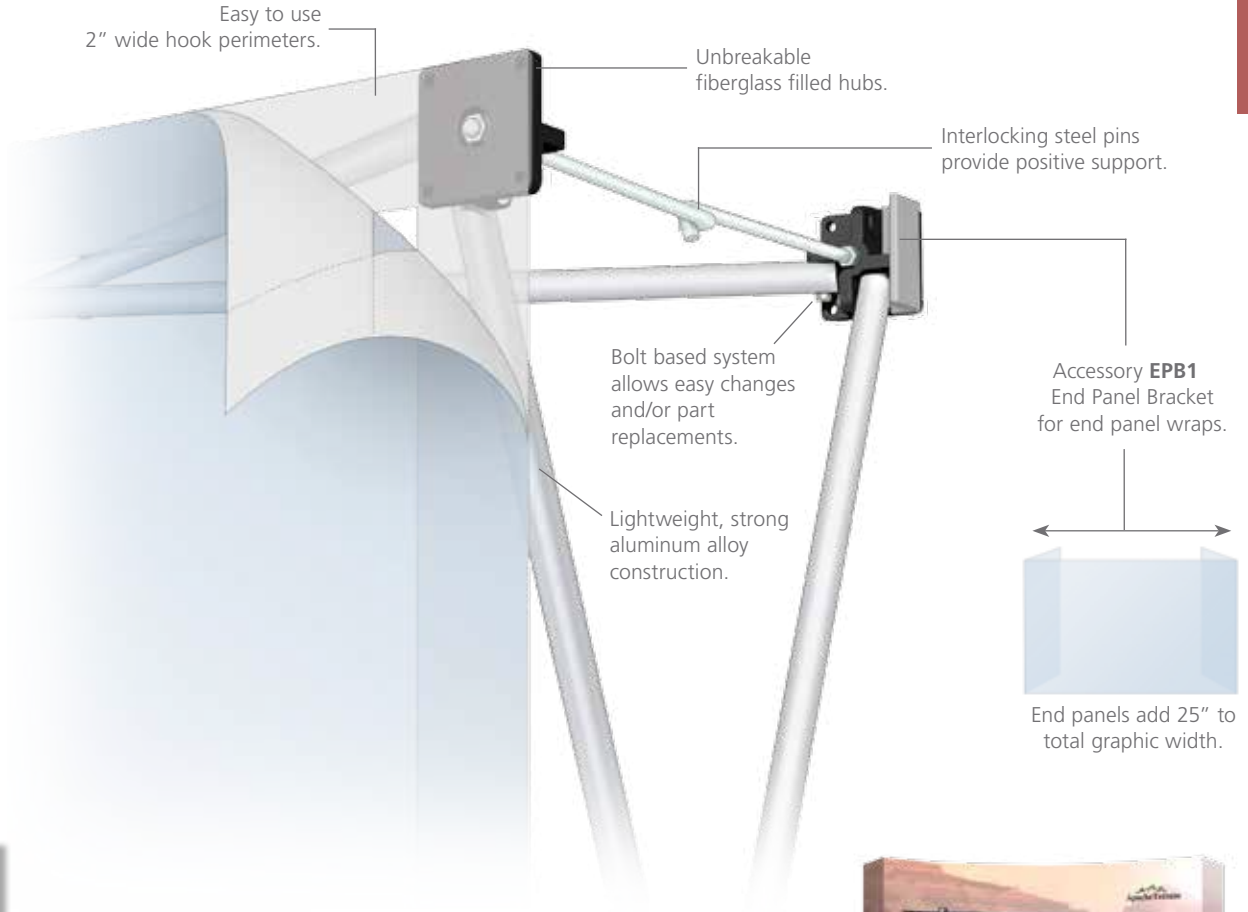

Fabric Graphics

High impact 720 DPI Dye Sub Printing on a virtually "wrinkle free" stretch fabric, designed and engineered for this application. Custom printed from your art work.



Curved Presto Frame **PFK43C**, **GF43BC** graphic with end panels.

Presto Pop-Ups™

End Panel Brackets facilitate the wrapping of the sides, adding 25" to total graphic width. A bracket is needed for each outer hub and assembly is easy.

Both straight and curved units can have their sides wrapped.

To completely enclose the frame - front, back and sides, End Panel Brackets are required, plus an extra Velcro® brand hook perimeter.



EPB1 Brackets easily attach to frame with screws.



JB1 Joining Brackets join frames together, call to determine quantity.



Curved unit with end panels:

PFK43C curved frame, **EPB1** end panel brackets (8), **GF43BC** graphic face



Completely enclosed on 4 sides:

PFK32 straight frame, **EPB1** end panel brackets, **32VB** extra hook perimeter, **GF32A** and a **GF32B** graphic.

Superwide Presto Pop-Ups™



We will custom produce Pop-Up Frames to any quad configuration, no matter how many quads.

The Velcro® brand perimeters, are sewn in our own factory to exacting specifications.

Quads are always 30" square. Large frame assemblies more than 15 quads do not include carry bags.

For pricing contact our friendly sales department.

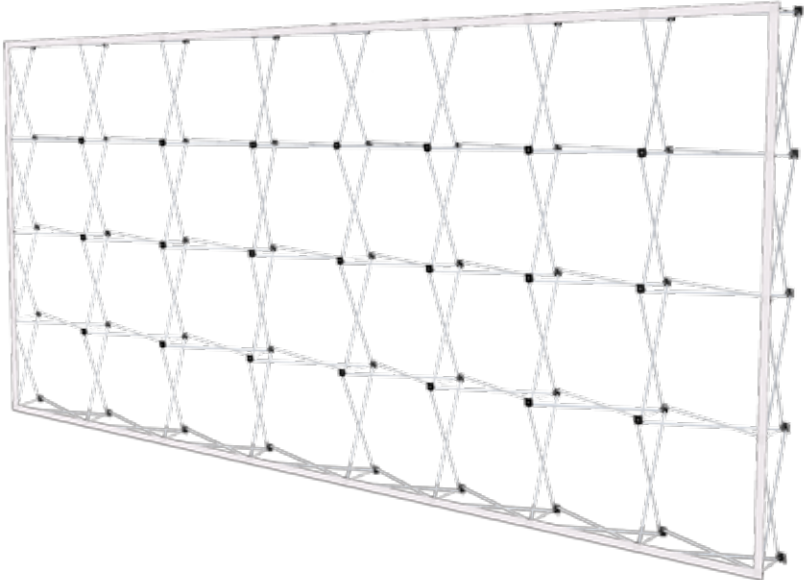

Presto Pop-Up™ Light Kits

LIGHT KITS TO MAKE YOUR POP-UP SHINE!

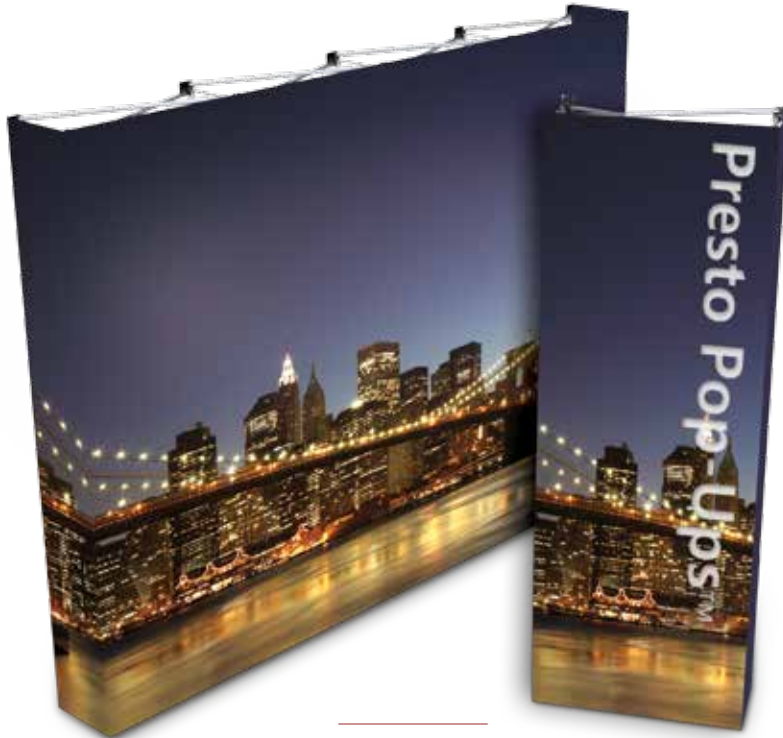

SOLD AS COMPLETE KITS

Each kit includes:

- A lamp & fixture for each quad
- Power supply cords & power strip
- Carry bag to keep kit contained.

Pop-Up Light Kits

Model	Quads w x h	Model	Quads w x h
PFKLK13	1 x 3	PFKLK43	4 x 3
PFKLK22	2 x 2	PFKLK44	4 x 4
PFKLK23	2 x 3	PFKLK53	5 x 3
PFKLK32	3 x 2	PFKLK33C	3 x 3 Curved
PFKLK33	3 x 3	PFKLK43C	4 x 3 Curved

Disclaimer: Though we use clear hubs, sometimes they create visible shadows - depends on graphic pattern.

Features:

- Sold as a complete kit
- Quick easy assembly
- Long lasting TS lamps
- Connecting cords & power strip
- Aluminum brackets snap to frames
- Good for 1 sided or 2 sided Pop-Ups
- Energy efficient, easy to replace lamps
- Carry bag keeps parts contained



Cool white fluorescent lamps connect in series, one for each quad. Aluminum mounting brackets make set up very easy.

Presto Pop-Up™ Accessories

Extra Bags (imported):

SNB1 33" x 12" x 13"
up to 3 x 3 frame

LNB1 33" x 18" x 13"
up to 5 x 3 frame



Podium Cases: (imported):

Hard plastic designed for Pop-Ups. Doubles as a Podium; add a Graphic Wrap to deliver your message.



Hook Perimeters:

Use with end panel brackets for enclosing frame on all sides.

13VB	23VB	33VB	44VB
22VB	32VB	43VB	53VB

OPC1	24" w x 15-1/2" d x 38" h (O.D.) Podium Case. Simulated wood top
GFW1	Graphic for OPC1. Size: 70-1/2" w (includes 2" overlap) x 31" h

OPC2	16-1/4" w x 14-1/2" d x 34-3/4" h (O.D.) Half Podium Case
GFW2	Graphic for OPC2. Size: 50-1/2" w (includes 2" overlap) x 27-1/2" h

Weighted Base

PFKWB Laser cut marquee shaped steel bases. Must be ordered with frames, as we pre-punch matching holes.



Pop-Up Lights (imported)

PULD1 Very bright LED trade show light for Pop-Ups, 18w.



LEDPU for Pop-Ups.



Use for: Presto Pop-Ups, Collage Pop-Ups, & most other manufacturers pop-ups.

Mercury Retractable Banner Stands™



RY1-S with LEDBR1 light.

MOST RELIABLE, BEST VALUE RETRACTABLE ANYWHERE!

- Sleek new styling
- Telescopic Pole
- Lightweight, portable
- Assemble without tools
- Handsome finishes
- No loose parts to lose



Matte black



Top crossbar with knob



RY1-S-HC hardcase kit

Model	Description	Width	Weight (lbs.)
RY1	1-sided	36"	12
RY2	2-sided	36"	18
RY3	1-sided	24"	11
RY4	2-sided	24"	14
RY5	1-sided	48"	14
RY6	2-sided	48"	23
RY7	1-sided	60"	18
RY8	2-sided	60"	29

Free Soft Travel Bag with every unit!

Model	Banner Stands with Hard Shipping Case	Weight (lbs.)
RY1-B-HC	RY1 36" single sided, black with hard case	25
RY1-S-HC	RY1 36" single sided, silver with hard case	25
RY2-B-HC	RY2 36" double sided, black with hard case	31
RY2-S-HC	RY2 36" double sided, silver with hard case	31
RY3-B-HC	RY3 24" single sided, black with hard case	24
RY3-S-HC	RY3 24" single sided, silver with hard case	24
RY4-B-HC	RY4 24" double sided, black with hard case	27
RY4-S-HC	RY4 24" double sided, silver with hard case	27

Case Dimensions 43" w x 14.5" d x 5" h

Specify: **-S** Satin Silver **-B** Matte Black



Good for many types of media substrates- vinyl, fabric, laminated film and more.*

*15 mil max. Laminate one side only. Must be pliable to roll up tightly.

MODELS UP TO 60" WIDE

- Infinite height adjustments 36" to 96"
- Very lightweight & portable
- Available single and double sided
- Instant set-up and take-down
- Telescopic pole system
- Aluminum construction
- Satin finishes

Mercury Retractable Banner Stands™

VELCRO® BRAND HOOK/LOOP MOUNT TOP & BOTTOM

Tremendous value & still made in the USA!

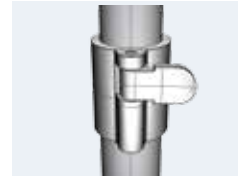
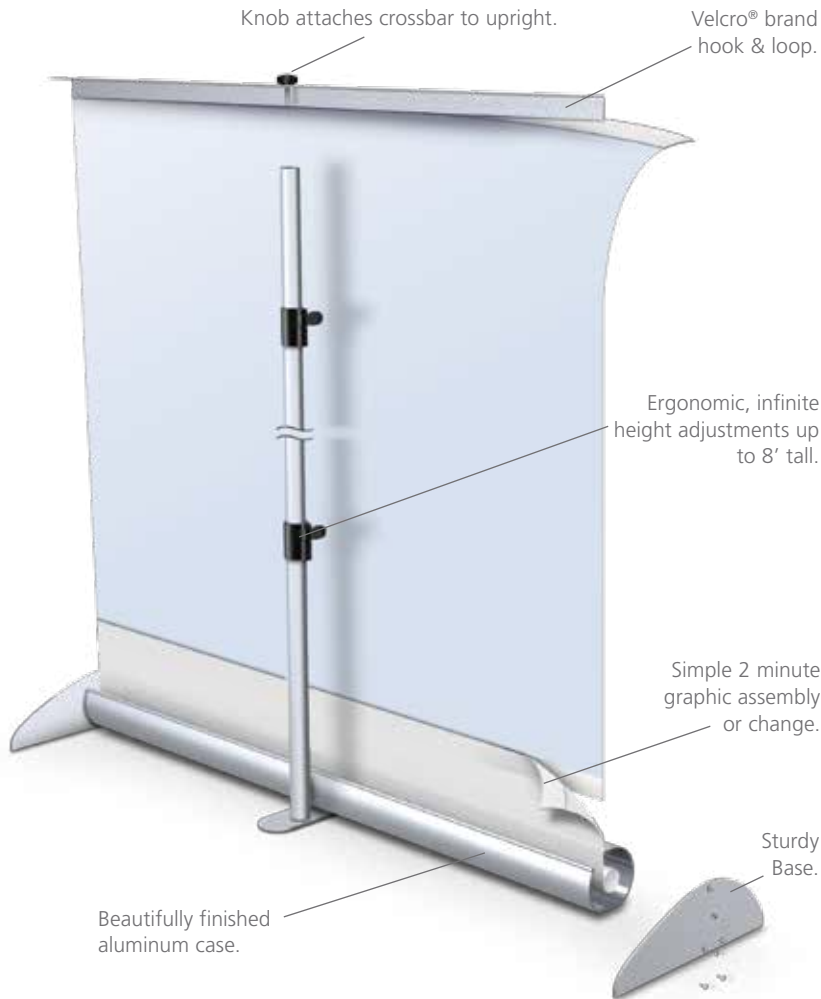

"G" Lock allows quick height adjustments.



2-sided case

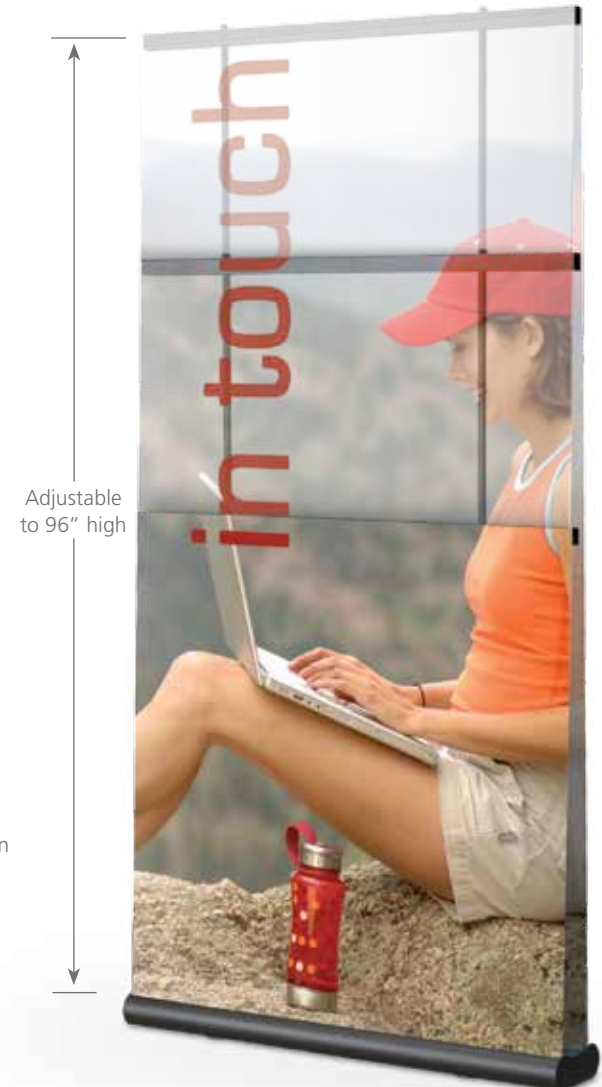

Compare ours versus the competition

- Tool-free assembly
- Infinitely adjustable up to 8 feet high
- Easy to use Velcro® brand hook & loop
- Free soft travel bag with every unit
- Built to last
- An incredible quality & value proposition
- Still made in the USA with pride!

Note: we use only Velcro® brand hook & loop with a pressure sensitive adhesive specially formulated not to damage graphics.

Hook comes attached to bar & leader. The loop attaches to the graphic top & bottom.

Classic Banner Stands™

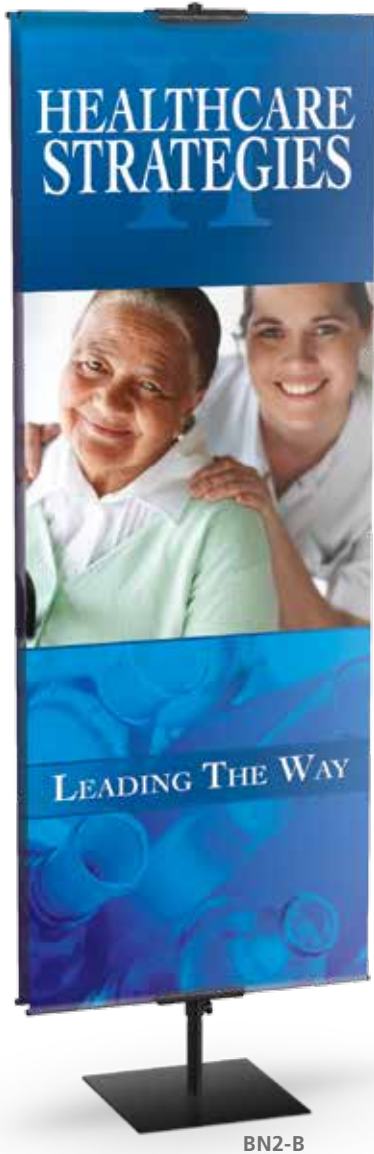

POLE POCKET MOUNTING

Featuring:

- Adjustable height center poles and lightweight metal construction
- Top dowel holder attaches to pole top, bottom dowel holder can travel up & down
- User friendly and built to last!

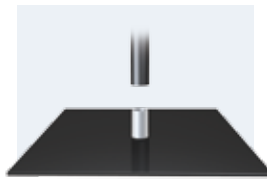

Square and round bases feature solid support bushing.



Solid aluminum adjustable clutch lock.



BN2SQ-B with **LED BR2** light, and **PB1C** Brochure Holder.

QUALITY & VALUE

Model	Banners	Width	Sq. Base	Telescopic Height
BN1	1 or 2	12"	8"	24 - 42"
BN2	1 or 2	24"	12"	36 - 96"
BN3	1 or 2	36"	16"	42 - 118"

Colors:

- S Satin Silver
- B Matte Black

STANDARD BASES



12" Square. Heavy duty steel with inner support bushing & baked on powder coated finish.



TB Travel Base: Steel, modern design. Fits travel bag. Textured powder coated finish. No extra cost.

HEM GRAPHICS TOP & BOTTOM, DOWELS PROVIDED



Simply hem banners top & bottom, put dowels in and slide into holders.

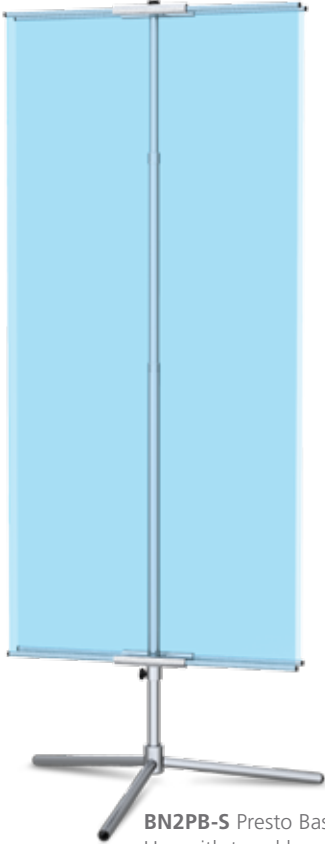

EXTRA COST BASES



RD Round Base: Heavy duty steel bases, beautiful baked on powder coated finish.
BN1: 1/8" x 6-3/4" (1-1/2 lbs.)
BN2: 3/16" x 11" (5 lbs.)
BN3: 3/16" x 15" (9 lbs.)



PB Presto Bases with internal shock cord mechanism, assembles like Presto! Use with travel bags.

Classic Banner Stands™



PB presto base.



TB travel base.

VELCRO® BRAND HOOK/LOOP MOUNT

- Trouble free clutch for secure locking
- Adjustable height 36"-96" center poles
- Bottom crossbar can travel up & down
- User friendly and built to last!
- Hook/Loop Mount top crossbar attaches to pole top

Available Colors:

-S	Satin Silver
-B	Matte Black



Oval crossbars with Velcro® brand Hook/Loop included.



Bottom crossbars can be raised and lowered.

Square Base	Travel Base	Presto Base	Round Base	Graphic Width
BV2SQ	BV2TB	BV2PB	BV2RD	24" Single
BV2DSQ	BV2DTB	BV2DPB	BV2DRD	24" Double
BV3SQ	BV3TB	BV3PB	BV3RD	36" Single
BV3DSQ	BV3DTB	BV3DPB	BV3DRD	36" Double

Custom variations available!

STANDARD BASES



Standard bases are square with inner support bushing, in a handsome satin silver or matte black finish.



TB Travel Base: Modern design. Fits travel bag. Textured powder coated finish. Same cost as square base specify TB.

VELCRO® BRAND HOOK/LOOP MOUNT



BV2SQ-B with **LEDBR1** light and **PB1C** Brochure Holder.

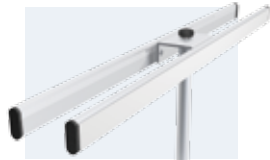

Crossbars feature aluminum brackets and Velcro® Brand Hook/Loop.



Centerpoles accept graphics 36" to 96" tall.



Solid aluminum adjustable clutch lock.

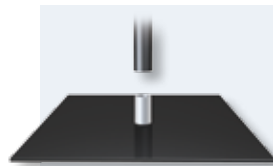

Solid inner bushing ensures stability.



Accessories
Lights, Bags &
Literature Baskets available.



RD round base.



TB travel base.

EXTRA COST BASES



RD 11" Round 5 lb. base: Heavy duty steel bases, with inner support bushing, satin powder coated finish.



PB Presto Bases: Internal shock cord mechanism, assembles like Presto! Specify **PB**. Use with travel bags.

Nexus SnapBar Banner Stands™

NO GRAPHIC END FINISHING REQUIRED!



NX22-S

Aluminum satin anodized extrusions are strong and lightweight.

Metal springs provide great gripping power.

Easy Open SnapBars hold graphics firmly in place top & bottom

Tacky foam compresses ensuring a strong grip. Holds graphics to 1/16" thick.

Graphic end finishing not required.



Single Sided

OR

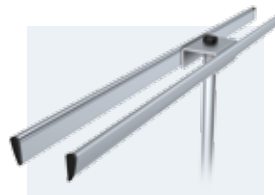

Double Sided

>



Fully Adjustable

SNAPBAR GRAPHIC MOUNTING

- Trouble free clutch for secure locking
- Adjustable height 36"-96" center poles
- Bottom crossbar can travel up & down
- User friendly and built to last!
- No graphic end finishing required



Centerpoles accept graphics 36" to 96" tall.



Solid aluminum adjustable clutch lock.

Choices:

1 sided or 2 sided
24", 30" or 36" width

- S Satin Silver
- B Matte Black

Model	Description	Width
NX21	1-sided	24"
NX22	2-sided	24"
NX251	1-sided	30"
NX252	2-sided	30"
NX31	1-sided	36"
NX32	2-sided	36"



Solid inner bushing ensures stability.
12" square steel base standard.



Optional Travel Base:
Folds up. Same cost - specify -TB.



Accessories: Lights, Bags
& Literature Baskets available.

INSTANT IMPACT



NX31TB-B



NX22-B

Harmony Banner Stands™

Is this the world's easiest to assemble, easiest graphic change banner stand system ever?



HMN4

Harmony Banner Stands

- 1" constant diameter clear anodized uprights. Sleek design.
- Swaged, spring button, and shock chord construction.
- Curved tops adds extra focus.
- Full width steel bases 12" deep offer substantial support.
- Tubing is clear anodized, Base color: Satin silver or matte black.
- Lightweight and portable.

Standard Models

Model	Base Width	Graphic Width	Height	Accessory Bag
HMN1	24"	23-1/2"	72"	EBP-2
HMN2	30"	29-1/2"	72"	EBP-3
HMN3	36"	35-1/2"	72"	EBP-3
HMN4	24"	23-1/2"	84"	EBP-2
HMN5	30"	29-1/2"	84"	EBP-3
HMN6	36"	35-1/2"	84"	EBP-3

Base Color: -S Satin Silver -B Matte Black



HMN4



HMN5



HMN6

Pillowcase Mounting

Very Fast Assembly

All Metal Construction

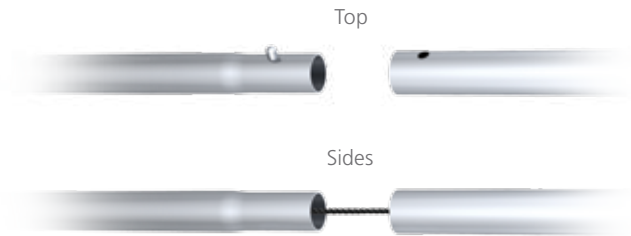

Swage, spring button, and shock-chord construction. Tool-free Assembly.

Packaging is very efficient & thus shipping is correspondingly inexpensive.



Accessory Bag EBP-2 inside dimensions 3" x 12" x 24"

Accessory Bars are available that accept standard slatwall shelves & accessories.

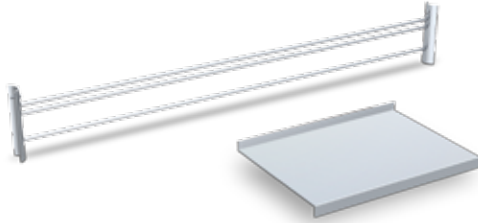

HMNB1	24" Accessory Bar
HMNB2	30" Accessory Bar
HMNB3	36" Accessory Bar
HMNS1	9-1/2" x 7" Accessory Shelf

These bars will NOT fit standard models.

The stands need to be prepared with mounting holes.

Specify how many accessory bars you would like per stand & our friendly sales staff can offer pricing on a project basis.



Graphic changes in less than 1 minute!

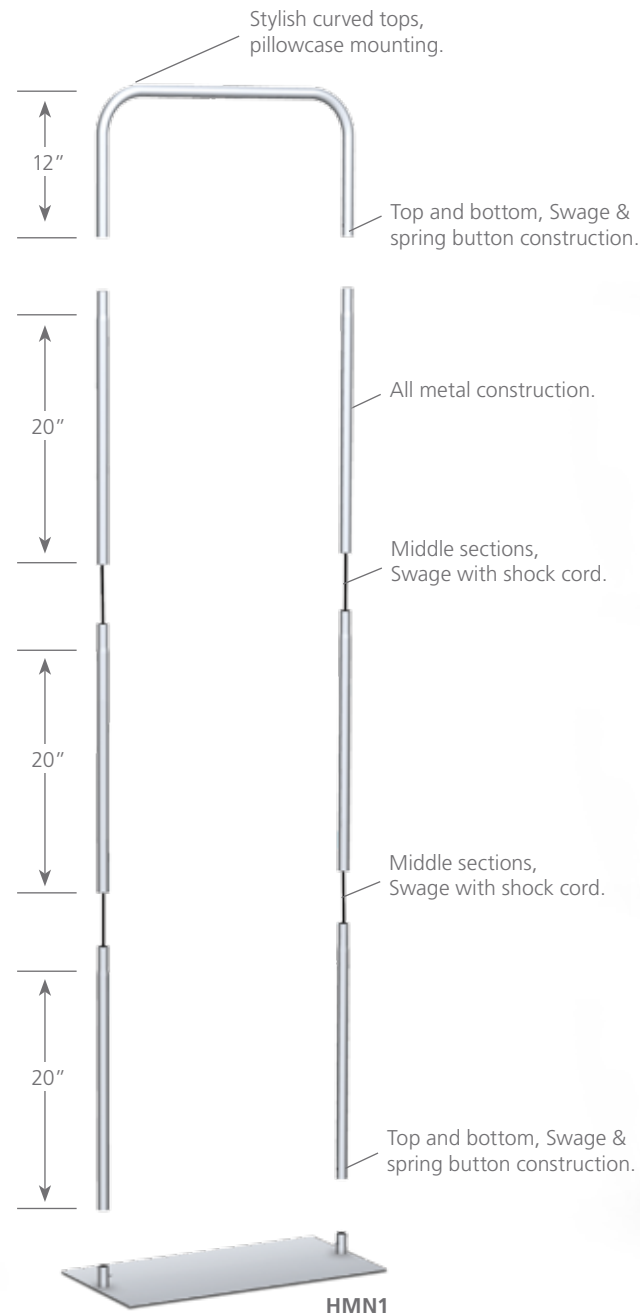

HMNS1 shown with three shelves and accessory bar assemblies.

Quest Banner/Sign Stands™

ALL METAL
QUALITY & VALUE

- Telescopic aluminum tube, opens to 7'
- Quick easy 2 minute assembly
- All metal unit-welded top, built to last
- Handsome matte finishes

FOR GRAPHICS WITH HOLES OR GROMMETS



QBS2H-B



QBS2H-B



Solid aluminum
adjustable clutch lock.



Curved 25" long top steel rod.
2 welded metal J hooks
set on 18" centers.

SHOVEL BASE CAN FIT
UNDER SKIDS OR PRODUCT.

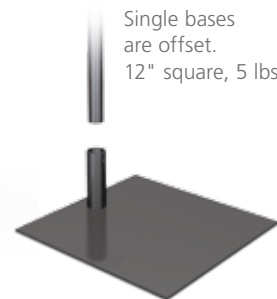

Single bases
are offset.
12" square, 5 lbs.

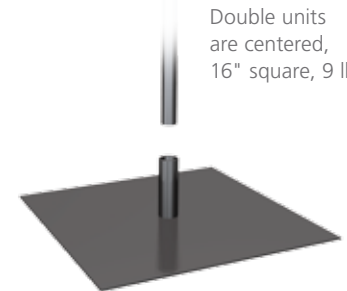

Double units
are centered,
16" square, 9 lbs.

Featuring 6" long support sleeves.

Single Wing Quest

QBS2H 25" curved rod with 18" centered J hooks

Double Wing Quest

QBS3H (2) 25" curved rods with 18" centered J hooks

Specify Colors:

-S Satin Silver **-B** Matte Black

Accessories

SnapGraphic Gripper Bars

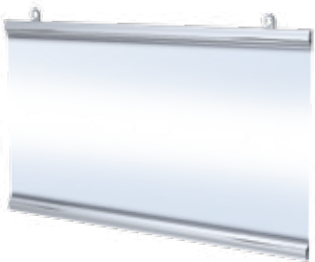

Includes top & bottom grippers plus 2 universal mounting clips.

- No pockets or graphic end treatment required
- Grip graphics to .70 mil (.070") thick

GC22-C 22" **GC24-C** 24"

Dowel Kit with Eyebolts

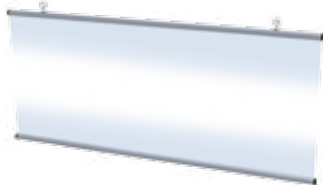

- 5/8" diameter - removable eyebolts on 18" center to center.

QBDK2 24" long dowel kit (set of 2)

Choose: **-S** Satin Silver **-B** Matte Black



- Perfect for many retail applications.
- Custom versions available in quantity.

CUSTOM MADE
MODELS AVAILABLE

Ultra UB Banner Stands™



Floor-to-Top Graphics
(No Visible Feet)

VELCRO® BRAND HOOK/LOOP MOUNT



Weighted bottom bar
includes hook & loop.



Alloy top bar also
includes hook & loop.



Spring loaded design
creates graphic tension.

Featuring:

Floor-to-top graphics, no visible feet, an incredibly clean look

Beautiful Black Matte Finish

- Suitable for any substrate
- "Footless" Design, floor-to-top graphics
- Clean edge to edge display
- Spring-loaded graphic tension
- Two minute assembly and take down
- Easy to assemble, pressure sensitive adhesive
- Hook & loop included for the top & bottom
- Telescopic aluminum alloy assemblies
- Modern curvilinear design & matte black finish
- Ideal for most inkjet media

Model	Height	Banners	Width	Wt. (lbs.)
UB324	42-72"	Single	24"	5
UB336	42-72"	Single	36"	7
UB424	42-72"	Double	24"	7
UB436	42-72"	Double	36"	9



EBGX

Travel Bags (imported):

EBGX For 36" & smaller models.

EBG8 For 48" models.

LARGE FORMAT SIZES

Model	Height	Banners	Width	Wt.
UB524	42-96"	Single	24"	6 lbs.
UB536	42-96"	Single	36"	8 lbs.
UB548	42-96"	Single	48"	9 lbs.
UB624	42-96"	Double	24"	7.5 lbs.
UB636	42-96"	Double	36"	9 lbs.
UB648	42-96"	Double	48"	11 lbs.

... Spring loaded design creates graphic tension

Handsome Matte Black Finish

3 Presentation Angle Positions

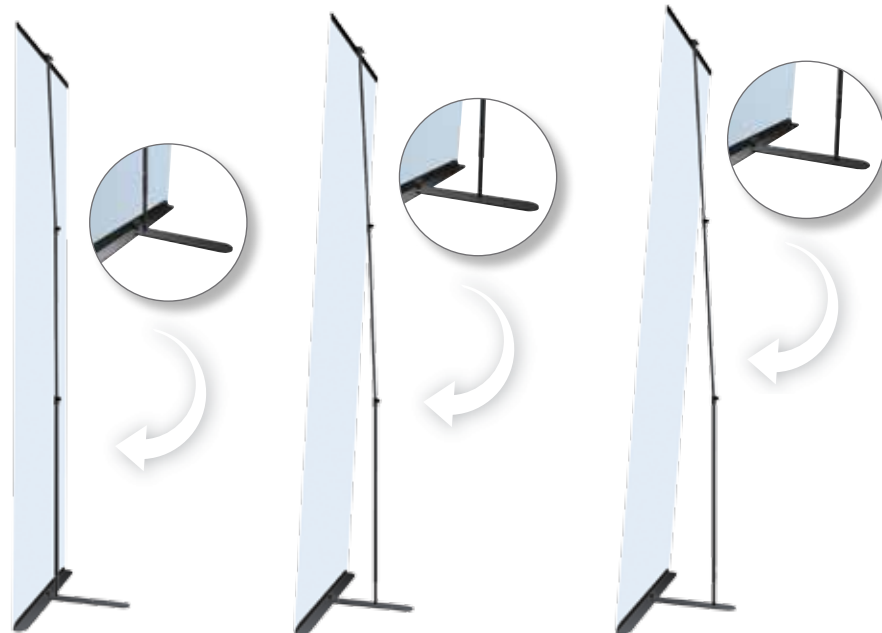

UB548 48" single sided



Double units have radiused bottom legs.
Center support is held with knobs.



GripGraphic Banner Stands™



GS2-S
with square base.

SNAPGRAPHICS GRIPPER BARS™

Ingenious bar snaps closed after graphic insertion with incredible strength, torque and care.

- 4 bars included with every stand
- Telescopic uprights with knurled locks
- Display 1 or 2 graphics, back to back

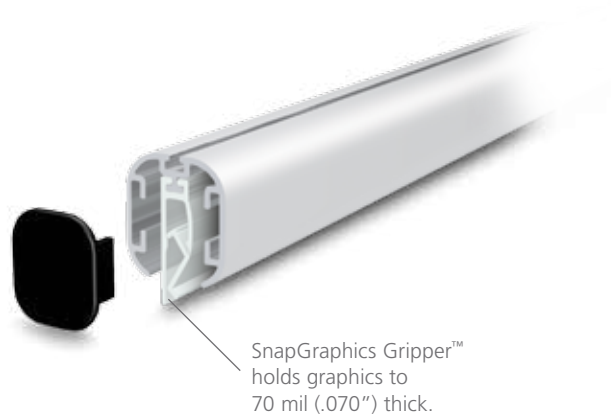

Model	Height	Width	Standard Base*	Presto Base PB **	Round Base RD **
GS2	36" - 96"	24"	12" square	Shock Chord	11"
GS3	42" - 118"	36"	16" square	NA	15"

-S Satin Silver or -B Matte Black ***TB** Travel Base same cost **Extra cost



GS2RD-B
with round base.

STANDARD BASES



Standard bases are square with inner support bushing, in a handsome matte silver or black powder coated finish.



TB Travel Base: Modern design, fits travel bag. Powder coated finish. Same cost as square base specify **TB**.



Diamond pattern knurled twist lock.

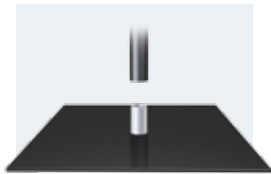

Inner bushing ensures stability of square & round bases.

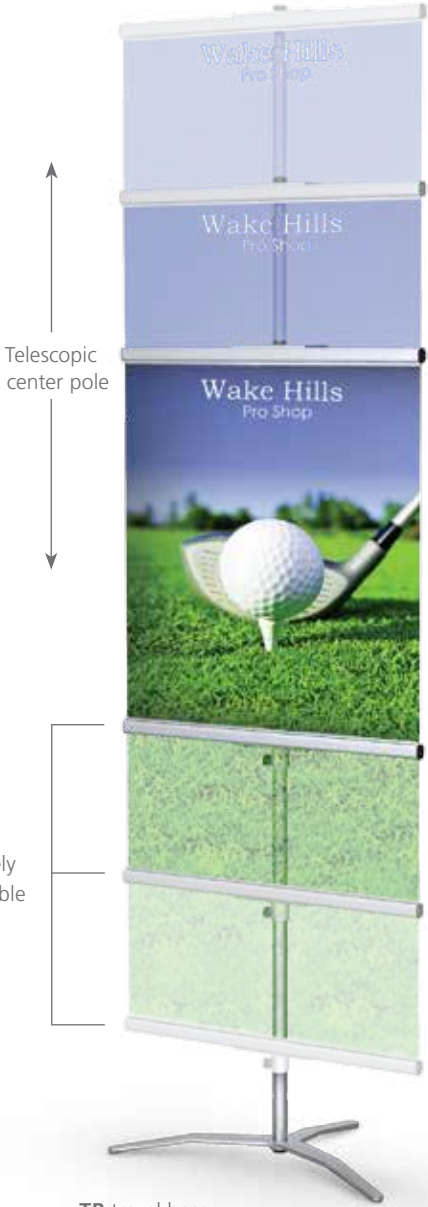

ACCESSORIES
Lights, bags, literature baskets available.



PB1C & PB2C for GS2.
PB3C & PB4C for GS3.

EXTRA COST BASES



RD Round Base: Heavy duty steel bases, with inner support bushing, satin powder coated finish. Perfect for retail environments.



PB Presto Bases: Internal shock cord mechanism, assembles like Presto! Specify **PB**. Use with travel bags.

GCO GripGraphic Banner Stands™



GRIPGRAPHIC BARS™

Oval co-extruded bars deliver exceptional gripping power at an economical price point.

- No pockets or graphic end treatment required
- Telescopic upright holds graphics up to 96" high
- Closes easily once graphic is inserted
- Bars hold 24" wide graphic media to 3/32" thick

No pockets or graphic end treatment required!

GCOBS1	Holds one 24" Banner
GCOBS2	Holds two 24" Banners

SATIN SILVER FINISH

ACCESSORIES



PB1C

Literature baskets



PB2C



Bases feature an inner support bushing and a handsome matte satin silver finish.

Silver polymer cases simulate aluminum. (without the cost).

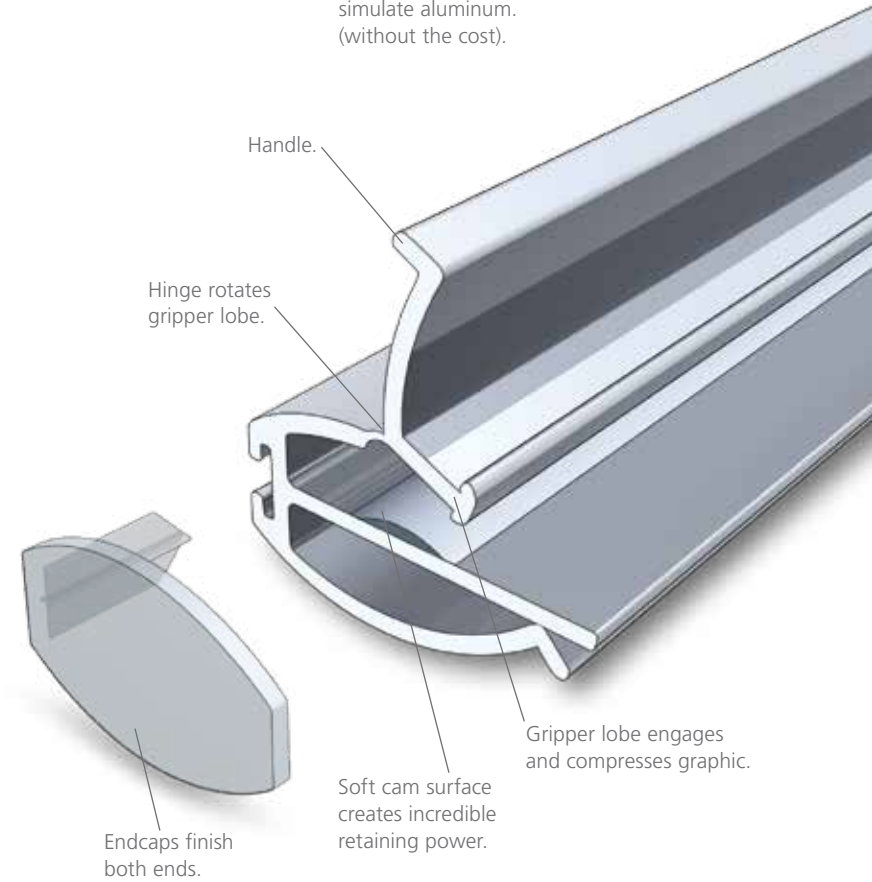

Handle.

Hinge rotates gripper lobe.

Endcaps finish both ends.

Soft cam surface creates incredible retaining power.

Gripper lobe engages and compresses graphic.

Patented Technology!

U.S. Utility Patent # 6,637,716
U.S. Design Patent # D-424,120

ECONOMICAL, PORTABLE!



BDG2-S

- 72" Height, single sided
- 12" square, 3-3/4 lb. base
- 1/2" Aluminum dowels
- Braided rope
- 2 section 1" tube assembly

Model	Width
BDG1	24"
BDG2	30"

-S	Satin Silver*
-B	Matte Black*

*Does not affect price



Diamond braided rope fits slot in dome shaped cap.



Inner bushing ensures stability of 12" square base.

Custom Models Available.

STURDY STEEL SHOWROOM STAND

- Holds one 28" wide hemmed banner
- 6' high, 1" diameter steel construction
- Bottom dowel supplied
- Handsome curvilinear design
- Two minute assembly



Perfect for automotive showrooms!



Use HEMMED GRAPHICS

Model	Color
LBS-B	Black

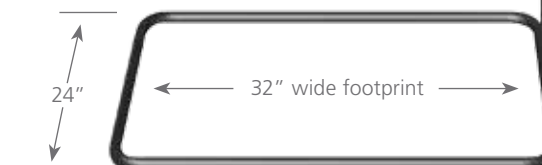

Promo Banner Stands™



MB2-B

Telescopic center pole

Infinitely Adjustable

PROMO BANNER STANDS

- Adjustable height, all stands accept graphics up to 72" high
- 3 Mounting Choices: Pole Pocket, SnapGraphic™, Hook/Loop
 - Great price points!

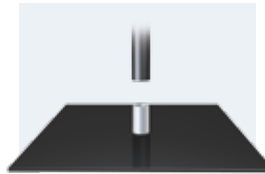

Solid inner bushing ensures stability.

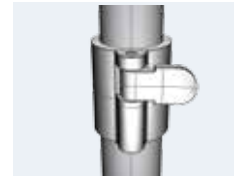

"G" Lock allows quick height adjustments to 72".
5/8" & 3/4" aluminum tube diameters.

Model	Mounting	Width
MB1	Pole Pocket	Single 24"
MB2	Pole Pocket	Double 24"
MB3	Hook/Loop	Single 24"
MB4	Hook/Loop	Double 24"
MB5	SnapGraphic™	Single 24"
MB6	SnapGraphic™	Double 24"

Other widths available special order.
Stands close to 38-3/8".

Specify Color:

-S Silver -B Black
same cost

STANDARD BASES



SQ Standard Square Base:
12" steel base, 3-3/4 lbs.
Powder coated finishes.



TB Travel Base:
No extra cost. Simply specify **TB**,
use with **EBGX** travel bag.



MB3SQ-B, shown with bottom holder 30" off floor, **LEDBR1** Light, and **PB5C** Brochure Holder.

POLE POCKET MOUNT

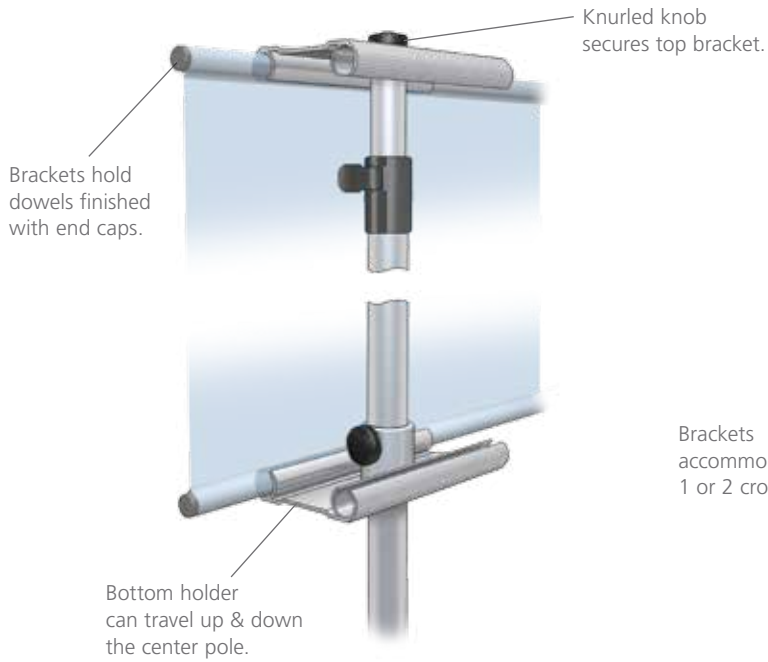

SNAPGRAPHIC™ MOUNT

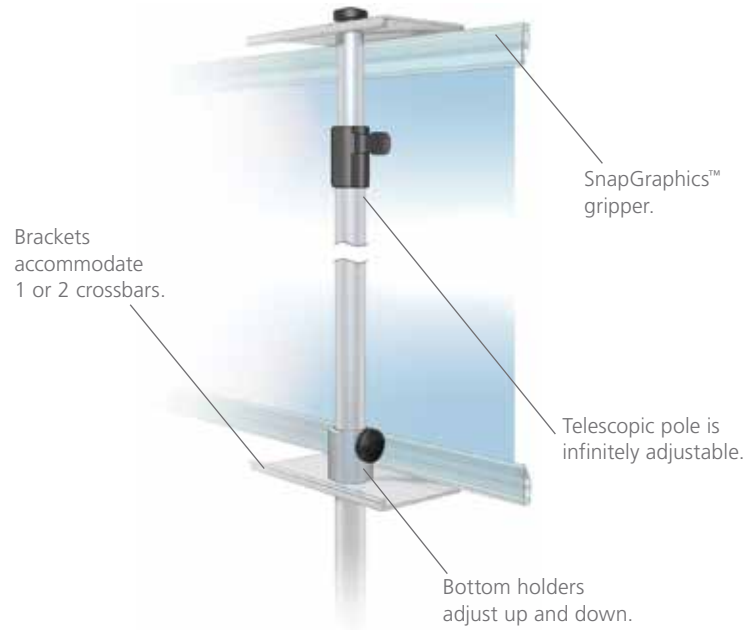

HOOK/LOOP MOUNT

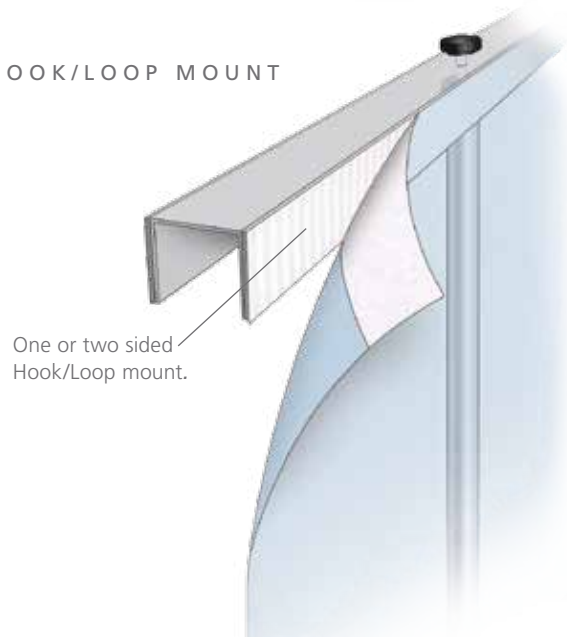

ACCESSORIES:
Lights, bags, literature baskets available.



Adjustable Large/Grand Format Banner Stands™

SUPER STURDY CONSTRUCTION — FEEL THE QUALITY DIFFERENCE



Adjustable width

Features:

- Telescopic height 36"-96"
- Pole pocket mounting
- Two 3" x 17" formed steel bases
- Great portability. 5 minute assembly

Standard Tubing

Model	Width	Upright Diameters	Crossbar	Hem
BN4	30"-48"	3/4"-7/8"-1"	1-1/8" Diameter	2"
BN5	52"-96"	3/4"-7/8"-1"	1-1/8" Diameter	2"
BN6	24"-42"	3/4"-7/8"-1"	1-1/8" Diameter	2"
EBG6	Travel bag suitable for above stands			

Specify Colors:

-S Satin Silver -B Matte Black

Jumbo Diameter Tubing

Model	Width	Upright Diameters	Crossbar	Hem
JN4	30"-48"	1-1/4"-1-3/8"-1-1/2"	1-5/8" Diameter	3"
JN5	52"-96"	1-1/4"-1-3/8"-1-1/2"	1-5/8" Diameter	3"
JN6	24"-42"	1-1/4"-1-3/8"-1-1/2"	1-5/8" Diameter	3"
EBG6	Travel bag suitable for above stands			

Note: For heavy weight vinyls & graphics, special order uprights with **B** locks. Extra cost applies.

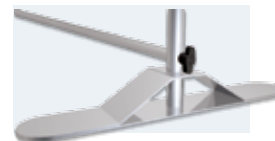

Sturdy Steel
"Bridge" Support Base.



Twist lock offers infinite
horizontal and vertical adjustments.

Adjustable Large/Grand Format Banner Stands™

ACCESSORIES:

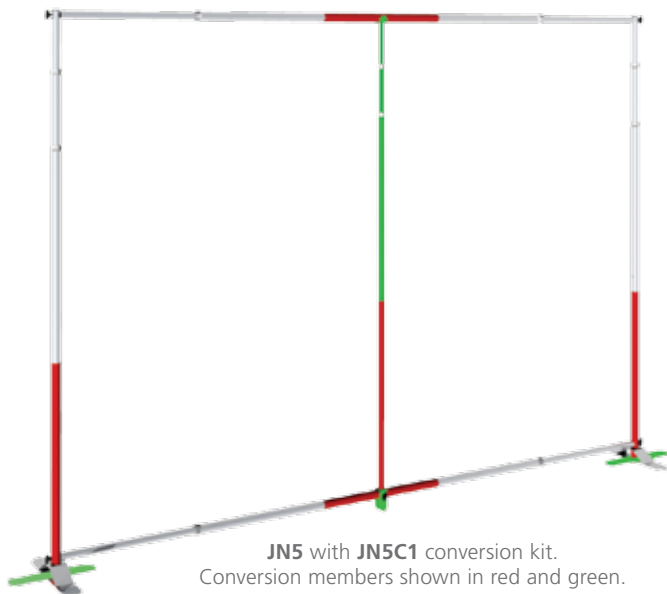

EBG-6 Bag (imported): Designed for these stands. One bag is required for each banner stand or conversion kit.

Snap-on—Literature Holders

PB1C	4" w by 2" d	pamphlet	BN's
PB2C	9" w by 2" d	catalog	BN's
PB3C	4" w by 2" d	pamphlet	JN's
PB4C	9" w by 2" d	catalog	JN's



PB1C/PB3C



PB2C/PB4C

Conversion Kits for Grand Format!

convert **BN5** & **JN5** up to 10' & 12' high & wide.

BN5C1	10' Kit for BN-5	5 inserts & 1 center support
BN5C2	12' Kit for BN-5	10 inserts & 1 center support
JN5C1	10' Kit for JN-5	5 inserts & 1 center support
JN5C2	12' Kit for JN-5	10 inserts & 1 center support
EBG6	Travel bag holds 1 conversion kit	
EBGH	Travel bag holds 1 conversion kit & 1 banner stand	

Note: Center support requires a notch in the banner back.

Specify Colors:

-S Satin Silver **-B** Matte Black



EBGH Travel Bag (imported): will hold a banner stand and a conversion kit.

Extra Crossbar Kits

Accessory telescopic crossbar attaches anywhere along the uprights. Includes 2 snap-on glide sizes.

BN4SOC	for BN4
BN5SOC	for BN5
BN6SOC	for BN6
JN4SOC	for JN4
JN5SOC	for JN5
JN6SOC	for JN6

Rings

RG5 Set of 4 rings holds foam core or plastic graphics with grommets.



Classic Fixed Width Banner Stands™

LIGHTWEIGHT, STRONG - POLE POCKET MOUNTING

- Aluminum alloy
- Tube diameters 3/4"-7/8"-1"
- Telescopic height 36"-96"
- Hem for 3/4" diameter crossbars

Specify: Model—Base*—Color*

Model	Crossbar Width
B2X	24"
B25	30"
B3X	36"
B4X	48"

Base*	
BR	Bridge
RD	9" Round Base

Color*	
-S	Satin Silver
-B	Matte Black

*Does not affect price, but must use to order.

Step Crossbar Kits

Adapters and a bar for attaching banner anywhere on upright.

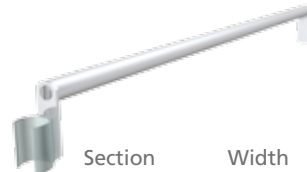

Section	Width
SCK1	24"
SCK2	30"
SCK3	36"
SCK4	48"



EBG6 (imported): Bag for bridge base models, 36" max.

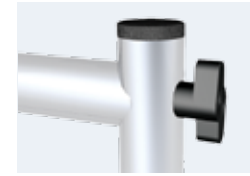

Super strong construction.

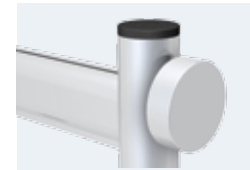

PK aluminum pucks an extra cost option, offer a sleek clean look.



Bridge Base

Round Base



B4XRD with **PK** Pucks in lowered position

TOWERS & PARTITIONS - POLE POCKET MOUNTING

- Telescopic height 36"-96"
- Tube diameters 3/4"-7/8"-1"
- Attractive 9" round bases
- Hem for 7/8" diameter crossbars
- 5 minute set-up

Triangular Tower	Square Tower	4 Section Partition	Crossbar Width
TR1	SQ1	PT1	24"
TR2	SQ2	PT2	30"
TR3	SQ3	PT3	36"
TR4	SQ4	PT4	48"
TW24	24" Vertical Extensions (sold each)		

Colors: -S Satin Silver -B Matte Black

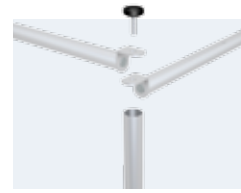

Easy assembly.

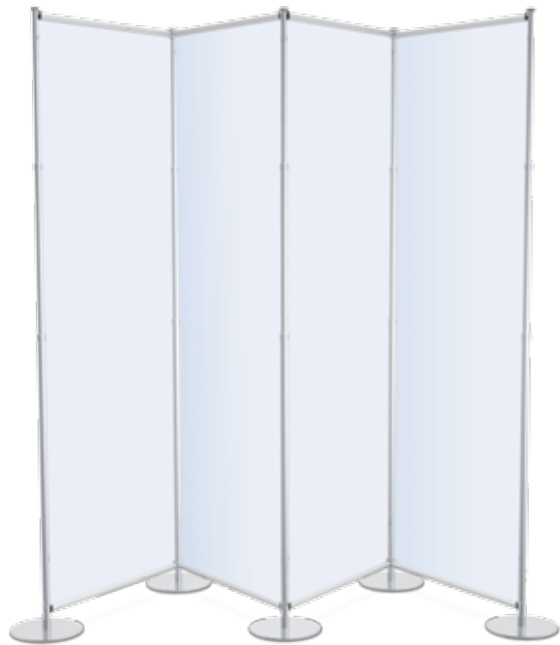

PT2



TR1 with PB1C pamphlet holders.



SQ2

Apollo SnapGraphics Stands™



SNAPGRAPHICS™ BAR

Holds any substrate up to 70 mil. thick.



Bottom crossbar can be set at
28" - 36" - 48" & 60" from top

No pockets or
graphic end treatments required!

Apollo™ Stands

- Aluminum alloy
- 70" tall uprights
- 9" round bases
- Patented Crossbars

Model	Wide
AS1	22"
AS2	24"
AS3	36"
AS4	48"
AS5	60"

Options:	
-S	Satin Silver
-B	Matte Black

PK Aluminum Pucks
rather than knobs



Round knobs
standard

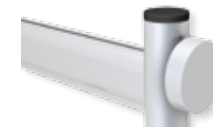

PK aluminum pucks
an extra cost option



Roll-A-Round
base available



Telescopic Apollo™ Stands

- Same great features as Apollo™, but height is telescopic to 90"
- 11" round bases
- Knurled twist lock for secure height adjustments
- 4 Positions for bottom crossbar at 4" - 18" - 24" & 30" off floor

SNAPGRAPHICS™ BAR

Holds any substrate up to 70 mil. thick.



Solid aluminum clutch lock.

No pockets or graphic end treatments required!

telescopes to 90"



Model	Wide
AST1	22"
AST2	24"
AST3	36"
AST4	48"
AST5	60"

Options:

-S	Satin Silver
-B	Matte Black

PK Aluminum Pucks rather than knobs



Bottom crossbar can be set at 4" - 18" - 24" & 30" off floor, while top bar is telescopic.

Literature Baskets



PB1C



PB2C

PB1C and **PB2C** snap on uprights.



AS1PB (Limited Use)

AS1PB and **AS2PB** must be ordered with stands.

PB1C	4" w x 2" d
PB2C	9" w x 2" d
AS1PB	for AS1 only
AS2PB	for AS2 only

Brochure Holders & Exhibit Lighting

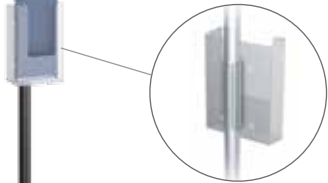
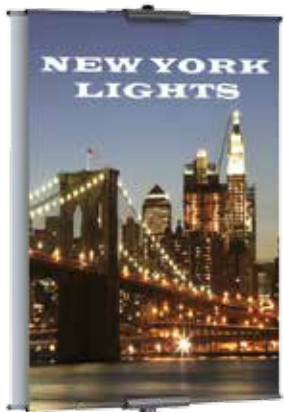

Simple Snap-on design.

BN2-B
with **PB1C**

Snap-on—Brochure Holders

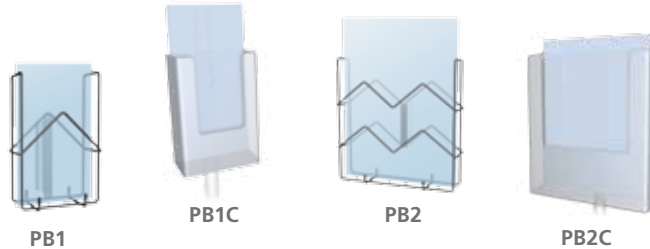

Wire	Acrylic	Size	Grip Diameter
PB1	PB1C	Pamphlet	1" diameter
PB2	PB2C	Catalog	1" diameter
PB3	PB3C	Pamphlet	1-1/2" diameter
PB4	PB4C	Catalog	1-1/2" diameter
PB5	PB5C	Pamphlet	3/4" diameter
PB6	PB6C	Catalog	3/4" diameter

Pamphlet: 4" w x 2" D

Catalog: 9" w x 2" D

Light Outfit



Light Outfit

Clamp On Exhibit Lights (imported):



EX4



UELA
Universal Exhibit Light

EX4	Bright 18w LED light with C clamp base - opens 1-1/2"
UELA	3" clamp, 18" flexible arm, aluminum reflector, accepts 75w max.

- Outstanding light source includes 10" diameter reflector and a special 75 watt bulb that simulates natural daylight.
- Ideal for mixing colors.
- Light canvas or model
- 3-section stand extends to 7'.
- Also available without bulb (124/3A).
- Weight: 4 lbs.

124/3A	Packed each in 2 boxes, 6 per carton
124/3A1	Same as above but individually boxed
124/3NL	Includes 75 watt North Light bulb that simulates daylight
75WNL	Bulb only
100/3	Light Stand only

Use above for two sided support models: BN6, BN4, BN5, JN4, JN5, and fixed width stands.

Cascade LED Lights™

For
Portable Graphic Stands, Pop-Ups
and Banner Stands

Imported



LED Light Source

- Extremely bright 450 Lumens
- Cool white color temperature
- 6 watt, 12 volts, 10-1/2" wide
- 50,000 working hour lifetime
- Wide movable swivel head



Accessory Bag fits all Cascade Lights
EBGC 22" x 4" x 3"



LEDBR1

Cascade LED Light Source with bracket for one-sided banner.



LEDBR2

2 Cascade LED lights with bracket for two-sided use.



LEDLF

Cascade LED Light Source with clamp for banner stand attachment.



LEDPU

Cascade LED Light Source with bracket for for Pop-Ups.



LEDCC

Cascade LED Light Source with C Clamp for multipurpose use.



Use for Banner Stands:

BN2, BN3, BV2, BV3, RY1, RY3, RY5, RY7 (2), NX21, NX251, NX31, GCOBS1, UB3, UB5, GS2, GS3, MB1, MB3, MB5.



Use for Banner Stands:

BN2, BN3, BV2, BV3, RY2, RY4, RY6, RY8, NX22, NX52, NX32, GCOBS2, GS2, GS3, MB2, MB4, MB6.



BN4, BN5 (2), BN6, JN4, JN5 (2), JN6, B2X, B25, B3X, B4X, Apollo Stands, Straight Flat Walls (2), Visual Graphic Stands, Cobra, Crescent, Mega Wave Walls, Cool C Walls.



Use for:

Presto Pop-Ups, Collage Pop-Ups, & most other manufacturers pop-ups.



Great for:

Table tops, and flat divider walls. Clamps to horizontal and vertical surfaces. Grip range open to 2-1/2".

Travel Bags



EBGX Bag with **BN-25TB** inside

EBGX For Models BN, BV, MB, and GS stands that have TB Travel Bases or PB Presto Bases. Also good for UB stands (except 48" models). Bag is 44" long & has top zippered compartment.



EBGH

EBGH Padded carry case, 39" long, features 4" round protected graphic holder and a compartment to hold lights and extensions. Good for all Model BN2, BV2, & GS2 Banner Stands with TB Travel or PB Presto Bases; also good for UB, JN4, 5, & 6, BN4, 5, & 6 Banner Stands.



EBG8

EBG8 54" long single compartment bag.

EBG9 63" long single compartment bag, (not shown).



LNB1

LNB1 33" x 18" x 13" Duffel type carry bag.



EBGC

EBGC 22" x 4" x 3" bag for lights.



EBG6 Bag with **BN4S**

EBG6 For all two-sided support models BN4, BN5, BN6, JN4, JN5, JN6, B2x8, B258, B3x8. Multipocketed bag has full length center zipper. Length 40".



EBGM

EBGM Huge, monster sized soft nylon bag, for multipurpose use. 79" w x 22"h x 2" d

SNB1 33" x 12" x 13" Duffel type carry bag. (not shown).



EBGLR

EBGLR Well designed nylon carry bag for portable use. Features a special compartment with straps to hold 12" square base securely. 24" x 9-1/2" x 12".

All bags on this page
are imported.

A TERRIFIC NEW PADDED BAG SERIES
with lots of great features sized for excellent utility.

Inside are tube compartments
and room for graphics.

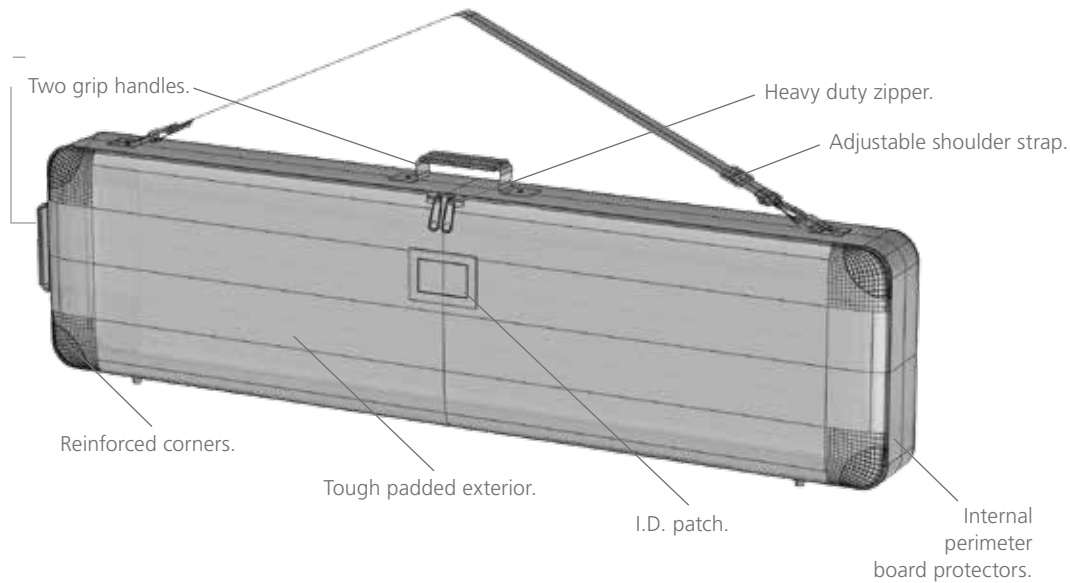

EBP2 Inside dimensions 3" x 12" x 24".



EBP3 Inside dimensions 3" x 12" x 36".

EBP2: HMN1, HMN4, VG62, PVT1, PVT2, SBR1TP, SBR2TP, SBR3TP, SBR7TP, SBR8TP, SBR9TP, 1PDTR, 1PPDTF, BN1

EBP3: HMN2, HMN3, HMN5, HMN6, RY1, RY2, RY3, RY4, BN2, BV2SQ, BV2DSQ, NX21, NX22, NX251, NX252, NX31, NX32, GS2, BN4, BN5, BN6, JN4, JN5, JN6, B2X, B25, B3X, TR1, TR2, TR3, VCST1, VCST2, FW088, VG63, VG64, VG82, VG83, VG84, C3, GCOB51, GCOB52, PVC3, PVC3C, PVC4, PVC4C, PVC5, PVC5C, PVC6, PVC6C, PVT3, PVT4

EBP4: RY5, RY6, CBR2, CBR3, CBR4, CENT2, CENT3, CENT4, UB324, UB336, UB424, UB436, UB524, UB536, UB548, UB624, UB636, UB648, MB1, MB2, MB3, MB4, MB5, MB6, B4X, SBR1, SBR2, SBR3, SBR7, SBR8, SBR9, C2, COH1, IPDSRD, IPDSSQ, IPHB2, IPHC1, IPHC2.

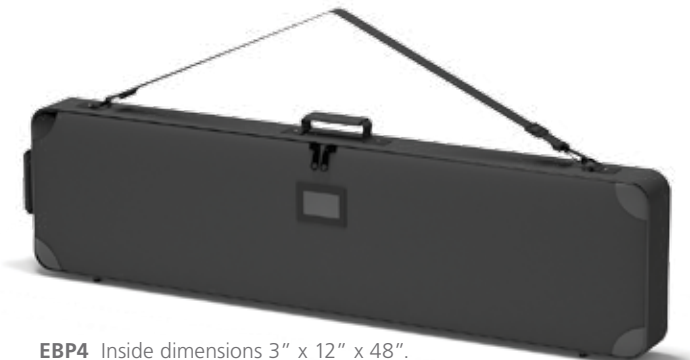

EBP4 Inside dimensions 3" x 12" x 48".

Hard Shipping Cases

Cases on this page are made in the U.S.A.

Made in the U.S.A.

Models: HC3919, HC4526, HC4840, HC5315, HC5325, HC6522:
Rugged thermoformed polyethylene construction

Models: HC4213, HC6317, HC6326: Fabricated board,
steel reinforced corners, riveted construction.

- Strong steel rubber grip handles
- Large 8" x 12" label area
- Steel rubber grip carrying handle
- Sturdy 1-1/2" straps with buckles
- Heavy duty built-in durable wheels



HC3919



HC4840



HC4526



HC5325



HC5315



HC4213



HC6326

HC3919	39" x 19" x 5-1/2"	20 lbs.	Thermoformed
HC4526	45" x 26" x 9-1/2"	28 lbs.	Thermoformed
HC4840	48" x 40" x 45"	27 lbs.	Thermoformed

HC5315	53" x 15" x 12"	25 lbs.	Thermoformed
HC5325	53" x 25" x 10"	34 lbs.	Thermoformed
HC6522	65" x 22" x 9"	33 lbs.	Thermoformed

HC4213	42" x 13" x 5"	11 lbs.	Fabricated Board
HC6317	63" x 17-3/8" x 12"	24 lbs.	Fabricated Board
HC6326	63" x 26" x 9-1/2"	30 lbs.	Fabricated Board

Note: Some of these cases ship dimensional weight, not actual weight via UPS or FedEx.

Podium & Exhibit Cases

Cases on this page are imported.

Podium Cases

Podium Cases are hard plastic designed for Pop-Ups. Doubles as a Podium, add a graphic wrap to deliver your message. OPC1: Wt. 40 lbs., OPC2: Wt. 26 lbs. OPC1 has a simulated wood top.



OPC1



OPC1 with GFW1



OPC2
(2 units shown)



Podium Travel/Storage Cases (imported):

OPC1	24" w x 15-1/2" d x 38" h (O.D.) Podium Case
GFW1	Laminated Graphic for OPC1. Size: 70-1/2" w (includes 2" overlap) x 31" h
OPC2	16-1/4" w x 14-1/2" d x 34-3/4" h (O.D.) Half Podium Case
GFW2	Laminated Graphic for OPC2. Size: 50-1/2" w (includes 2" overlap) x 27-1/2" h

Portable Exhibit Cases

Stylish design and versatile portability at a reasonable cost. Great for transporting Presto Pop-Ups™ and Collage Pop-Up™ units.

- Padded soft outer shell
- Rigid protective plastic liner
- Airline checkable
- Tough, yet lightweight



Wheels have protective outer enclosures.

EGC1	12" x 12" x 35"
EGC2	16" x 16" x 35"
EGC3	9-1/2" x 9-1/2" x 40"



Pull handle and side strap.



AIRLINE
CHECKABLE

EGC1

EGC2

EGC3

HAVE IT BOTH WAYS:
The light weight of a soft padded bag
WITH THE
Protection of a rigid liner



MODERN FRAMELESS DESIGN

Adjustable Depth

**HOLDS ANY RIGID SUBSTRATE
UP TO 1" THICK**

(as long as it holds its own weight)

Display graphics and attract buyers with single or double sided graphics. Our unique M shaped Steel Base assemblies accommodate up to 1" thick substrates.

Interior holes with carriage bolts and wing nuts support any rigid graphics. Make matching holes in graphics or use without holes by sandwiching graphic above the carriage bolts.

Extremely cost effective; graphics are displayed in a modern frameless fashion. Extremely sturdy as all the weight is centered on the floor.

3-1/2" Height off floor, 9" front to back.

MM14	14" L	6 lbs.
MM24	24" L	10.5 lbs.
MM36	36" L	15.75 lbs.
MM48	48" L	21 lbs.
MM60	60" L	26 lbs.

-S Satin Silver **-B** Matte Black

HT5 Rigid Graphic Clip hold graphics together up to 1/2" total thickness (sold 2 per.)

Also see
MiniMightee
page 66.



Sign Board (any, as long as it supports its own weight).

Bolt/wing nut.

Sleek steel stampings.

HOLDS RIGID SUBSTRATES UP TO 1-1/4" THICK

HT5 Rigid Graphic Clip hold graphics together up to 1/2" total thickness (sold 2 per.)

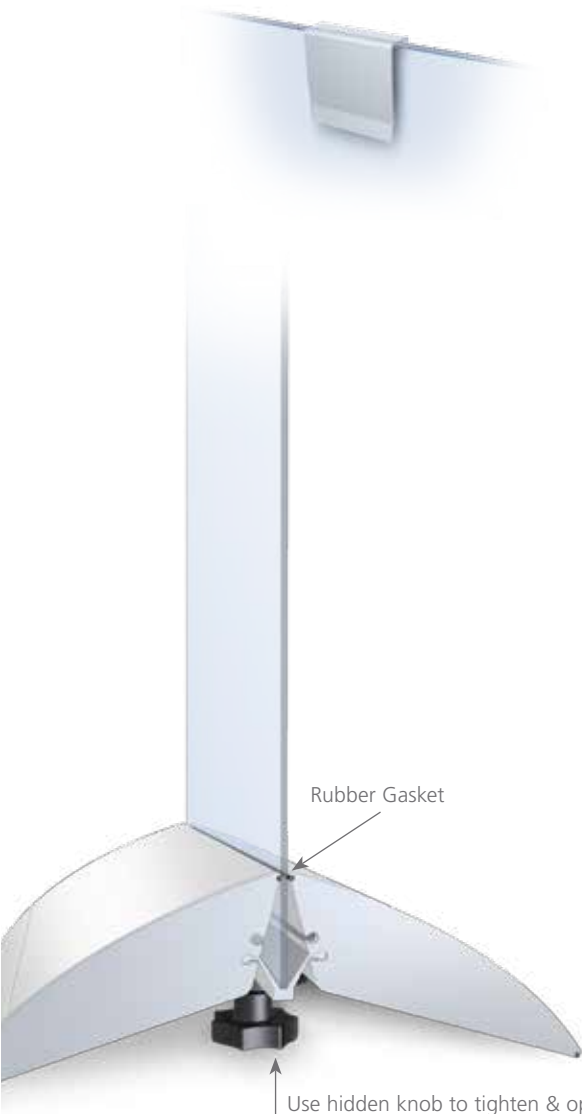

Rubber Gasket

Use hidden knob to tighten & open

- Sleek design supports any rigid graphic up to 1-1/4" thick.
- Lightweight aluminum base, allows quick graphic changes.
- Ergonomic bottom knob tightens rubber lined halves together firmly.
- 14-1/2" front to back, 5-1/2" high.

Use 2 units in series for larger graphics.

CM7	7" L	3.5 lbs.
CM14	14" L	6 lbs.
CM24	24" L	10 lbs.
CM36	36" L	15 lbs.
CM48	48" L	20 lbs.

-S Satin Silver -B Matte Black

Grips rigid substrates from 3/8" to 1-1/4" thick.



CM7-S



CM14-S

Double JL Mounts™

Heavy and Stable,
suitable for high traffic areas.

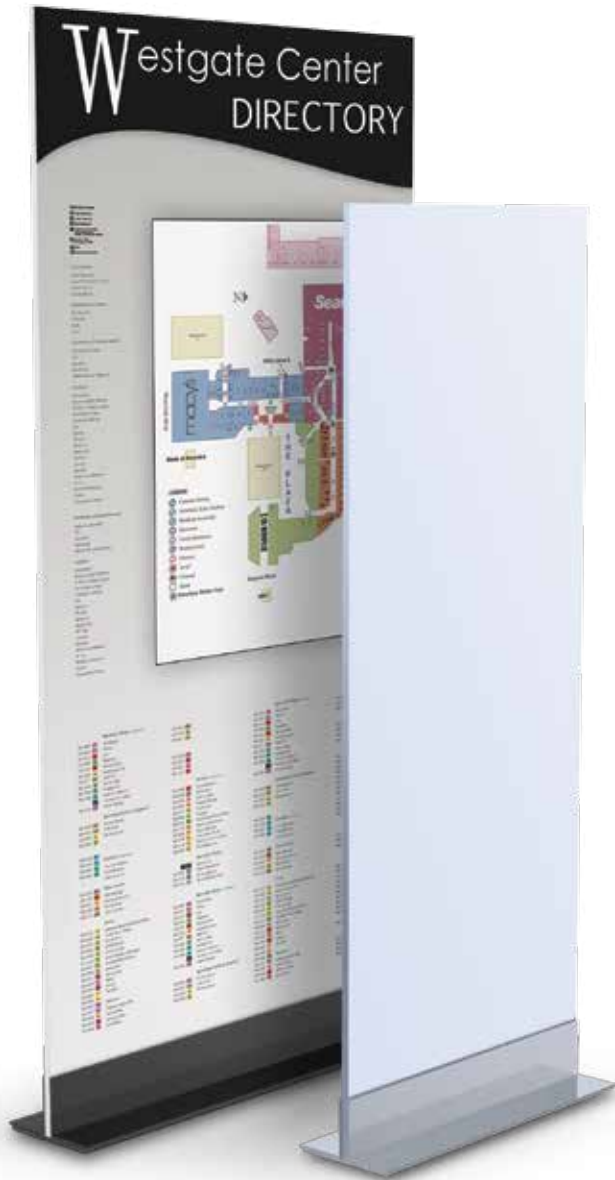

ACCEPTS 1/2" THICK GRAPHICS

- 4" High, 7-3/4" front to back
- Fixed 1/2" graphics depth
- Sits flat on any surface
- Features welded construction
- All metal, extremely solid
- Great for lobbies, tradeshow floors, malls, etc.

UNITS SHIP FULLY ASSEMBLED

LL14	14" L	12-3/4 lbs.
LL24	24" L	21-3/4 lbs.
LL36	36" L	32-1/2 lbs.
LL48	48" L	43-3/4 lbs.
LL60	60" L	54 lbs.

-S Satin Silver -B Matte Black

CUSTOM MODELS AVAILABLE

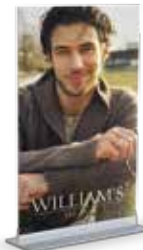

Also see
CounterTop Models
page 66.



Both the satin silver and matte black powder coat finishes feature fine textures, designed to withstand high traffic areas.

Adjustable Double JL Mounts™

Adjustable to accept a range of graphic thicknesses



ALL24

Simple 2 - piece construction



- 4" High, 15" front to back
- Adjustable for graphic thickness
- Grips 3/8" to 1" rigid substrates
- Sits flat on any surface
- All metal, extremely solid construction
- 2 piece construction ships and stores efficiently
- Great for lobbies, tradeshow floors, stores and malls
- Includes second set of screws to accommodate thicker substrate

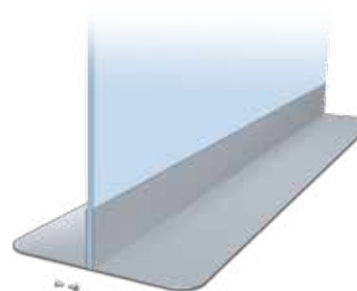

Both the satin silver and matte black powder coat finishes feature fine textures, designed to withstand high traffic areas.

ALL14	14" L	13 lbs.
ALL24	24" L	21 lbs.
ALL36	36" L	32 lbs.
ALL48	48" L	41 lbs.
ALL60	60" L	51 lbs.

-S Satin Silver -B Matte Black

Skyscraper Nightee Mounts™

STURDY SUPPORT FOR 1/2" RIGID GRAPHICS

Sold in pairs at specific heights, they support widths up to 60" wide.
For wider spans and right angle displays there are connection center uprights.

Kits include 2 side uprights with headless set screws and laser cut steel oval bases.

- Extremely attractive 1" x 2" racetrack oval aluminum uprights
- Choice of satin silver or matte black finishes
- Weighted steel bases
- Simple 5 minute assembly
- Portable, strong, lightweight
- View graphics front & back



SKMM7-S Skyscraper Mount with a **SKCU7-S** Center Upright.

Graphics can extend beyond upright top.
7/8" margin is required each side.
Headless set screws are provided along one side of uprights.

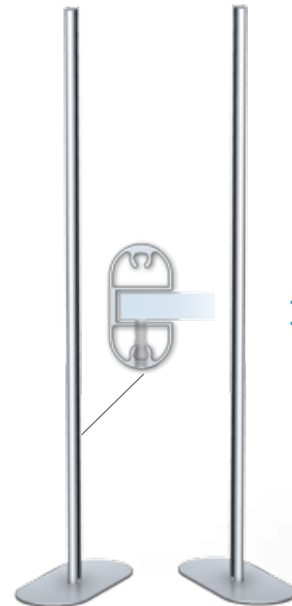
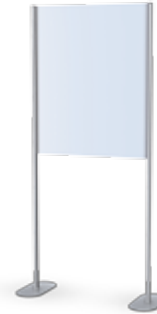
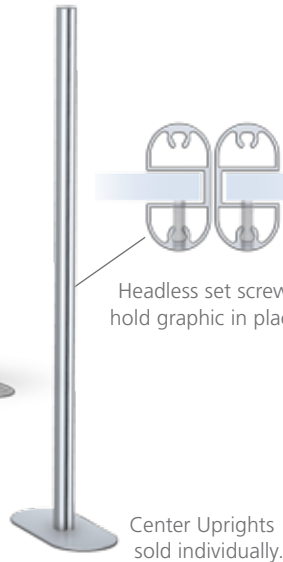
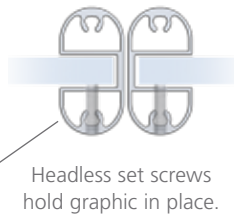

Skyscraper Mounts sold in pairs.



Skyscraper Mounts sold as a pair	Wt. (lbs.)	Center Upright sold individually	Wt. (lbs.)	Height
SKMM6	20 lbs.	SKCU6	14 lbs.	72"
SKMM7	21 lbs.	SKCU7	15 lbs.	84"
SKMM8	22 lbs.	SKCU8	16 lbs.	96"

Colors: -S Satin Silver -B Matte Black

RIGHT ANGLE, "T" AND "QUAD" CONFIGURATIONS

Right Angle two way assembly with round base, "T" and "Quad" assemblies include base and top plate. add single pole uprights to build your Skyscraper.

- Attractive oval aluminum uprights
- Weighted steel bases
- Portable, strong, lightweight
- Satin silver or matte black
- Simple 5 minute assembly
- View graphics front & back

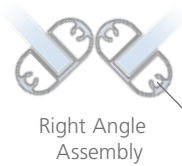

SKMM7-S Skyscraper Mount with a **SKRA7-S** right angle assembly.



SKRA right angle assembly with round base. Sold individually.

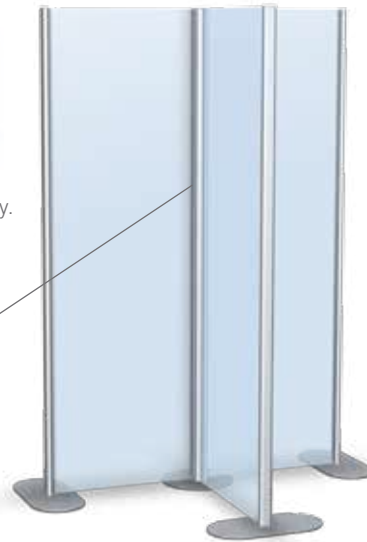
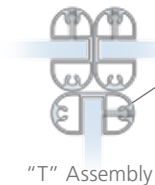

SKMM6-S Skyscraper Mounts with a **SKMS6-S** single sided upright and **SKTU6** "T" assembly.

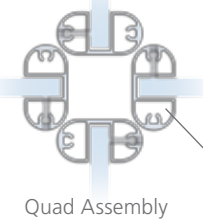

(2) **SKMM6-S** Skyscraper Mounts with a **SKX6** quad assembly.

SKMMC2 24" upright extension, sold individually.



SKMS Single upright and base, when just an odd upright is needed.

Right Angle Assembly sold individually	"T" Assembly sold individually	"Quad" Assembly sold individually	Single Sided Upright sold individually	Height
SKRA6	SKTU6	SKX6	SKMS6	72"
SKRA7	SKTU7	SKX7	SKMS7	84"
SKRA8	SKTU8	SKX8	SKMS8	96"

Colors: -S Satin Silver -B Matte Black

Pro iPad Stands*

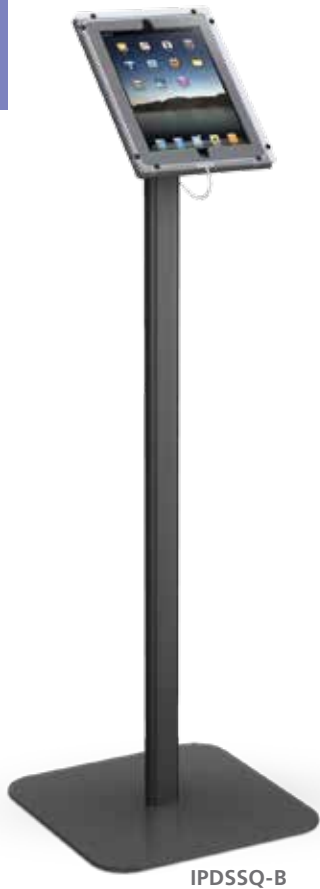

Pro iPad Stands

- Rotates from portrait to landscape
- Anti-theft hardware
- Metal back, uprights & bases
- High impact acrylic cover
- Included USB cable runs from the top, through the upright, down to the base
- Satin silver or matte black finish

Integral USB cable set included with all units.



Indicate model or USB cable required.

Custom quantity quotes available for any brand tablet or device.

Customization in quantity is our speciality.

Note: Not compatible with iPad 1 or iPad Mini.

Classic Pro iPad Stand

- Oval 37" high aluminum upright
- 13" round or 14" square steel base
- Weight: 11 lbs.

Specify: Model - Base* - Color*

Model

IPDS Floor Stand

Base*

SQ 14" Square

RD 13" Round

Color*

-S Satin Silver

-B Matte Black

Indicate tablet model (iPad 2, 3 or Air) or USB cable required (30 pin or lightning).

*Does not affect price.

IPDSHC - Complete Kit

Stand with Hard Case & custom designed polyethylene inserts for portability & storage.

Specify: **IPDSHC** - Base* - Color*

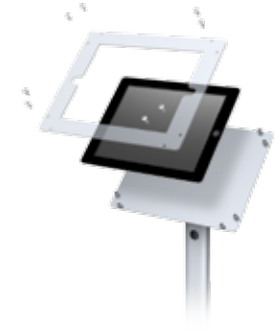

Tamper proof screws ensure secured enclosure.

360° Swivel
Rotates from portrait to landscape.



Pro iPad Stands*

MADE IN U.S.A. VALUE & RELIABILITY!

Classic Countertop / Wall iPad Stands
8" long post, 11" round or double flange base.

Wall Mount



IPDTW-S

CounterTop



IPDTR-S

Double Flange Base



IPDTF-S

360° Swivel
Rotates from portrait
to landscape.



Eye-Catching Digital
& Graphic Display
Presentations

All Metal Backs,
Uprights & Bases



Tamper proof screws
ensure secured enclosure.

Eclipse Pro iPad Stand

- Curved 43" h upright
- Welded construction
- Oval 9" x 14" base
- Weight: 10 lbs.



IPEC-B

IPEC-S

Specify: Model - Color*
Model

IPDTR	Counter Top, 11" Round Base
IPDTF	Double Flange Base
IPDTW	Wall Mount

Color*	
-S	Satin Silver
-B	Matte Black

*Does not
affect price.

IPEC Curved Floor Stand

-S Silver **-B** Black

Indicate tablet model (iPad 2, 3 or Air) or USB cable required (30 pin or lightning).

Mercury Retractable iPad Stands™

COMBINING OUR MERCURY RETRACTABLE WITH A TABLET DISPLAY

Hybrid Pro Mercury Tablet Stands

- Tablet rotates from portrait to landscape
- Anti-theft hardware
- Metal back, upright & base
- High impact acrylic cover
- Included USB cable runs from the top, through the upright, down to the base
- Satin silver or matte black finish

Integral USB cable set included with all units.



Indicate model or USB cable required.

Custom quantity quotes available for any brand tablet or device.

Customization in quantity is our speciality.



Tamper proof screws ensure secured enclosure.

IPRY1-S-HC
hardcase kit



Specify: Model - Tablet* - Color*

Model	Description	Banner Width
IPRY1	single sided	36"
IPRY1-HC	single sided w/hard case	36"
IPRY3	single sided	24"
IPRY3-HC	single sided w/hard case	24"

Tablet* (same cost)

-A	iPad Air (Models 1 & 2)
-I	iPad (Models 2 & 3 only)

Color* (same cost)

-S	Satin Silver
-B	Matte Black

Retractable accommodate many types of media substrates- vinyl, fabric, laminated film and more.*

*15 mil max. Laminate one side only. Must be pliable to roll up tightly.

Note: Pro iPad and Hybrid Pro Tablet Stands not compatible with iPad 1 or iPad Mini. Tablets not included.



IPRY1-I-S with LEDBR1 light.



IPRY1-I-B

Mercury Retractable Features

- Infinite height adjustments 36" to 96"
- Very lightweight & portable
- Instant set-up and take-down
- Telescopic pole system
- Aluminum construction
- Satin finishes

Hybrid Pro iPad Stands™



IPHB2-S

IPHB2 Holds 24" wide hemmed banners/. Use 1 or 2 sided. Telescopic pole accommodates banners up to 96" high. Weight: 14 lbs.

-S Satin Silver **-B** Matte Black

Custom models available in quantity.



IPHC2-S

Moveable aluminum clamps along 72" high aluminum pole. Holds rigid & semi-rigid graphics up to 1/2" thick.

Model	Style	Wt.
IPHC1	Single sided (2 clamps)	15 lbs.
IPHC2	Double sided (4 clamps)	15 lbs.

-S Satin Silver **-B** Matte Black



IPF2E07-S

Drop In Perfix Frames



SnapFrames

Front load, includes matte lens & styrene back.



Laser Cut Bases

10" x 14" oval. 7 lbs. Double bolt rock solid connections.



IPF2PX9-S

Note: Pro iPad and Hybrid Pro iPad Stands not compatible with iPad 1 or iPad Mini.

IPF Aluminum Frames are moveable along the 72" high upright. Choose either top load drop in frames or easy open front load SnapFrames.

Specify: Model – Frame Style – Color * *Does not affect price.

Model	Drop in Frame	Snap Frame	Color*
IPF1	1 Frame PX5 22 x 28	EO7 22 x 28	-S Satin Silver
IPF2	2 Frames PX6 24 x 36	EO9 24 x 36	-B Matte Black
	PX9 22 x 56	EO12 22 x 56	

Aluminum Slatwall

Bulk Slatwall — 1" on Center, Satin Anodized

Aluminum etched and satin anodized complements all environments.

- 1" on center aluminum alloy
- Etched & clear satin anodized
- Lightweight & strong
- Beautiful, modern design



Single Sided

Single Sided	Double Sided	Dimensions
LUMA48	LUMD48	6" high x 48" long
LUMA72	LUMD72	6" high x 72" long
LUMA96	LUMD96	6" high x 96" long
LUMA144	LUMD144	6" high x 144" long

Other lengths available.

6" high profiles nest together.
Height is a multiple of 6" plus 1/4".



Double Sided

Tons of standard accessories fit our slatwall:

- Lit. Holders
- Face Outs
- Shelves
- Hat Racks
- Jewelry Displays
- Baskets
- Hangers
- Cap Displays
- Shelf Brackets
- Signage
- Hooks
- Waterfalls

Single Sided Wall Mount Panels

All aluminum, clear satin anodized. Handsome finishing trim on two sides. Accepts all standard slat wall accessories.

Model	W" x H"
LUM2412	24"x 12-1/4"
LUM3612	36"x 12-1/4"
LUM4812	48"x 12-1/4"
LUM6012	60"x 12-1/4"
LUM2418	24"x 18-1/4"
LUM3618	36"x 18-1/4"

Model	W" x H"
LUM4818	48"x 18-1/4"
LUM6018	60"x 18-1/4"
LUM2430	24"x 30-1/4"
LUM3630	36"x 30-1/4"
LUM4830	48"x 30-1/4"
LUM6030	60"x 30-1/4"



Custom Requests Encouraged

Revolver Slatwall Stands

Modern and contemporary, 1" on center slatwall, satin anodized finish.

- Lazy Susan Swivel Base
- Saves on Floor space
- Double Sided
- Great for retail



Model	Dimensions
LUR54	16" Diam. Base x 54" high
LUR72	16" Diam. Base x 72" high

Portable Slatwall Stands

BEAUTIFUL SATIN FINISH

Contemporary
Modern
Look

- Lightweight & strong
- Etched & clear satin anodized
- Welded steel bases
- Racetrack oval upright
- Locking Casters
- Ultra easy assembly

Custom
Requests
Welcomed



Lockable casters
are included

Headers accept
22" w x 8" h graphics



Units top load



Rolling Base Assemblies are:
25" w x 21-1/4" d x 4" h

LUP11	One-sided Slatwall	70" h	LUP12H	Two-sided with header	70" h
LUP11H	One-sided with header	79" h	LUP22	Two-sided, 22" x 28" frame	70" h
LUP12	Two-sided Slatwall	70" h	LUP22H	Same with header	79" h



Slatwall starts about 16" up from the floor.

Pegboard to Slatwall Change-Out

Change out Lozier® & Madix® Gondolas with
Satin Anodized Aluminum Slatwall Back Panels.

Remove pegboard, insert clip at appropriate height on each side. Hang pre-assembled slatwall panel, replace header.

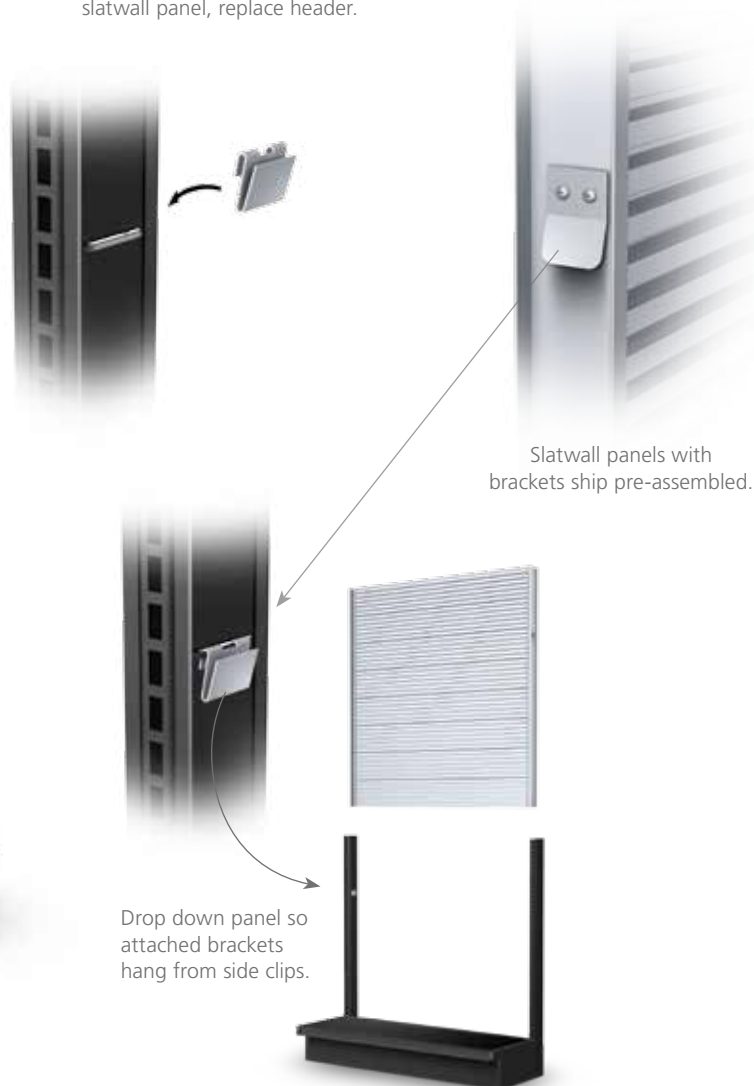

Specify: Model - Single or double sided, Brand*

Model	Panel to fit gondola
LUX0	36" x 54"
LUX1	36" x 60"
LUX2	36" x 72"
LUX3	36" x 84"
LUX4	36" x 96"
LUX5	48" x 54"
LUX6	48" x 60"
LUX7	48" x 72"
LUX8	48" x 84"
LUX9	48" x 96"

Specify:

Single or Double sided

-1 Single Sided

-2 Double Sided

Brand*

-Z Lozier

-M Madix

*Does not affect price.

Sizes are from the floor up, including the base.

Aluminum Slatwall Panels

Accessory Slatwall Panels/SignFrames

Panels include laser cut steel brackets for mounting to Lozier or Madix Gondolas.

Perfect when just sections of slatwall are wanted.

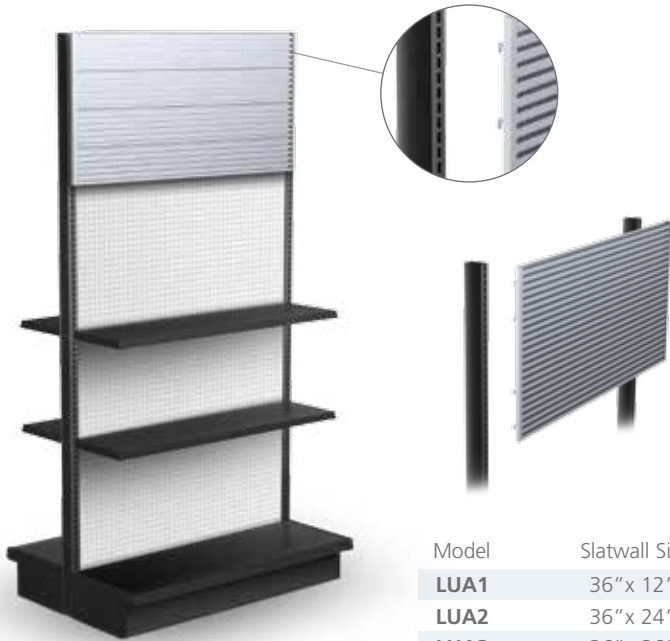

Model	Slatwall Size
LUA1	36" x 12"
LUA2	36" x 24"
LUA3	36" x 36"
LUA4	48" x 12"
LUA5	48" x 24"
LUA6	48" x 36"



Also available, Perfix drop-in & SnapFrames, that mount to Lozier or Madix Gondolas.

Power Wing Panels

Create more merchandising space. Includes mounting hardware.

Sturdy, Simple Clip-On Design!

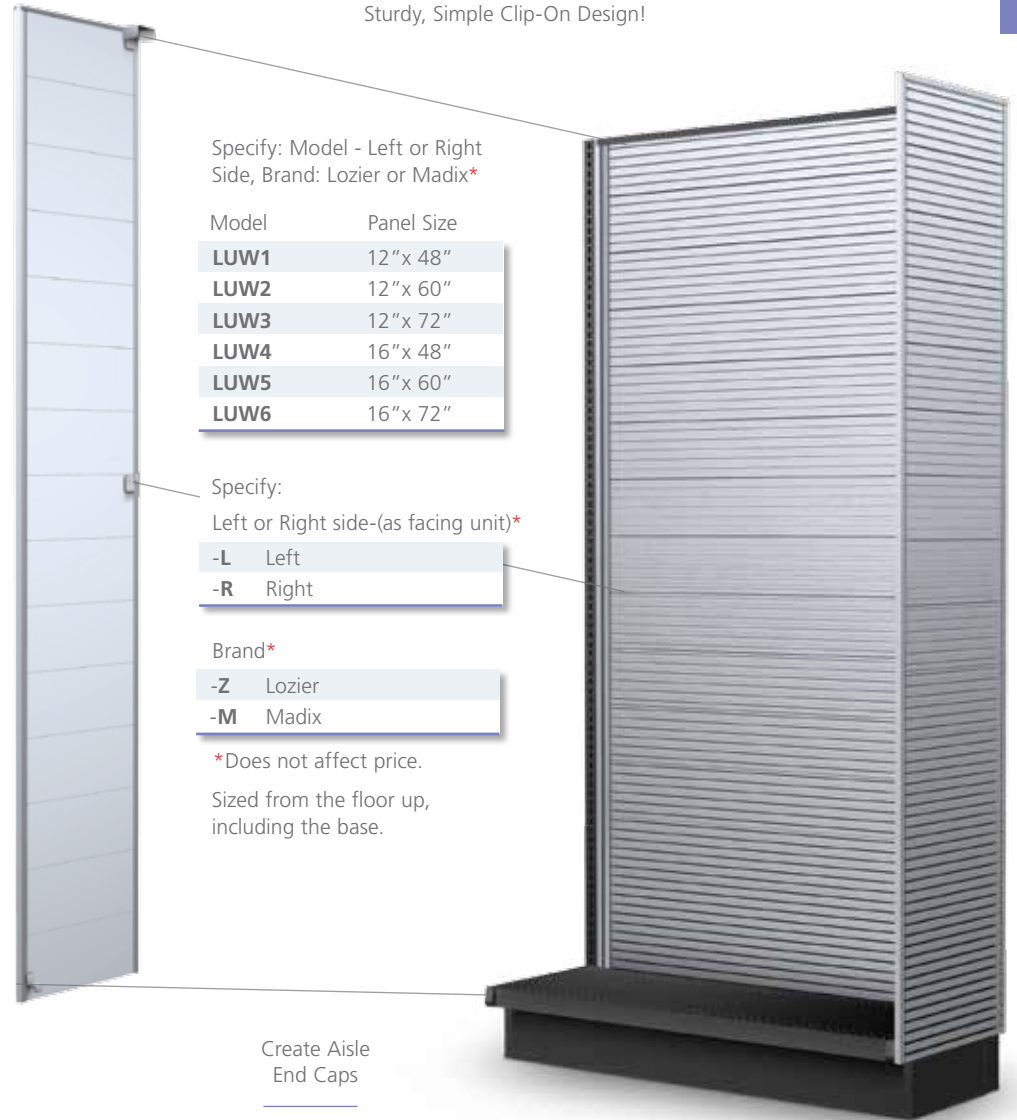

Specify: Model - Left or Right Side, Brand: Lozier or Madix*

Model	Panel Size
LUW1	12" x 48"
LUW2	12" x 60"
LUW3	12" x 72"
LUW4	16" x 48"
LUW5	16" x 60"
LUW6	16" x 72"

Specify:
Left or Right side-(as facing unit)*

-L	Left
-R	Right

Brand*

-Z	Lozier
-M	Madix

*Does not affect price.

Sized from the floor up, including the base.

Create Aisle End Caps

Accepts Standard SlatWall Accessories

Pallet, Catalog & Acrylic Sign Holders

PLT-1 PALLET SIGNHOLDER



Hooks fixed at 18" centered.

Also use with pole pocket banners, eyebolts are removable.

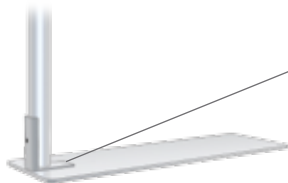

Electrically welded base bracket.

- Telescopic 72" high pole
- 24" long crossbar
- Satin silver finish
- Heavy duty shovel base 3/16" x 4" x 14" thick
- Hooks fixed at 18" centers

CATALOG HOLDERS



- Great for retail showrooms & lobbies
- All metal construction
- 11-1/2" high by 20" wide
- Angled 3-ring binder with pencil edge

Model	Base	Upright
PCS1	13" Round base	1" diameter, straight
PCS2	Oval base	1" diameter, curved

Choose: -S Satin Silver -B Matte Black

TELESCOPIC, ACRYLIC TOP STANDS



- 8.5" x 11"
- Acrylic Holders
- Telescopic poles 26"-50"
- Metal pedestal bases

Specify: Model - Base - Orientation* - Color*

Model

- S4** Slanted
- O4** Open Tray

Base

- SQ** 12" square
- RD** 11" round

Orientation*

- H** Horizontal
- V** Vertical

Color*

- S** Satin Silver
- B** Matte Black

*Doesn't affect price.

Simple & Clamp SignHolders

SIMPLE SIGNHOLDERS

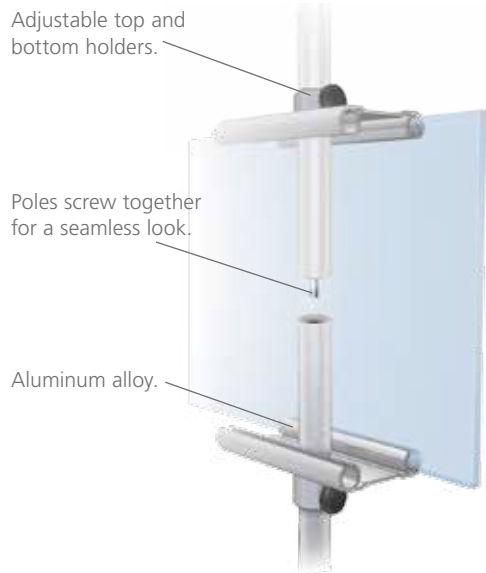

> Hold rigid substrates up to 1/4" thick.

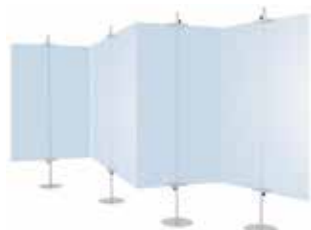

Great as Trade Show Corners.



SS2RD-S with ES2 extra holders.

Specify: Model – Base – Color*

Model	Height	Sections	Diameter	Base	Color*
SS2	72"	2	1"	SQ 12" Square	-S Silver
SS3	96"	3	1"	RD 11" Round	-B Black
ES2 Extra Holders for SS2, SS3 (2/set)				TB Travel	*Doesn't affect price.

SINGLE SIDED CLAMP STANDS

- Telescopic pole
- Several base choices
- Two clamp choices

Specify: Pole - Base - Clamp* - Color*

Pole

C2	2 section	38" - 72"
C3	3 section	36" - 96"

Base Steel, weighted bases

SQ	12" square (1/8")	- 5 lbs.
SQ2	16" square (1/8")	- 9 lbs.
RD	11" round (3/16")	- 5 lbs.
RD2	13" round (3/16")	- 8 lbs.

Clamps*

1. Black plastic, opens 1-1/4"
2. Plated steel opens 2"



Colors*

-S Satin Silver	-B Matte Black
-----------------	----------------

*Does not affect price.



C2RD21-S

Contemporary Clamp Stands



VCST1-S

CONTEMPORARY CLAMP STANDS

Featuring:

SOLID ALUMINUM SIGNING CLAMPS



- Solid aluminum alloy
- Anodized satin finishes
- 2" w x 3" h, rubber grips
- Clever binder spring
- Grip range up to 1/2" thick.



- Laser cut 5 pound round steel base
- Choose single or double sided
- Two section aluminum 1" diameter 72" pole assembly
- Choose satin silver or matte black finish

STANDS INCLUDE AN UPPER AND LOWER CLAMP

Extra Clamps:



VCEC1-S

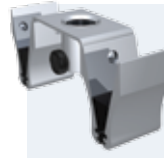

VCEC2-S

SINGLE AND DOUBLE SIDED ALUMINUM CLAMP STANDS

- VCST1** Single sided stand (2 clamps)
- VCST2** Double sided stand (4 clamps)

- VCEC1** Extra Single sided clamp set (2)
- VCEC2** Extra Double sided clamp set (2)

Specify: -S Satin Silver -B Matte Black



VCST2-S

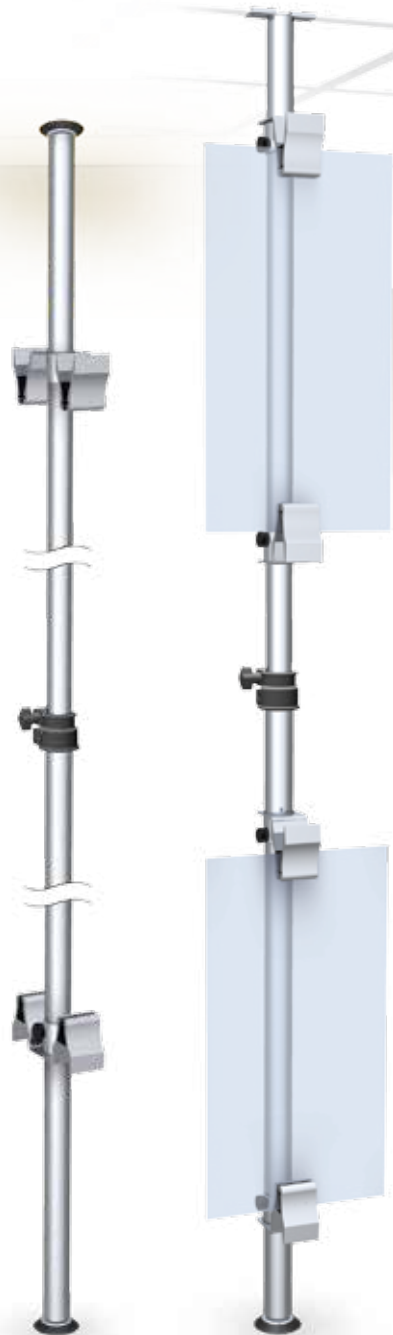

With 17" Round 12 lb. Base

- VCST31** Single sided (2 clamps)
- VCST32** Double sided (4 clamps)

- S** Satin Silver **-B** Matte Black

With Suction Cup Base

Specify: -Model -Top* -Color*

- VPP1** Single sided PortaPole
- VPP2** Double sided PortaPole

- | | |
|-----------------------------|------------------------|
| Top* | Color* |
| SC Suction Cup | -S Satin Silver |
| CG Ceiling Grid Clip | -B Matte Black |

*Does not affect price.

Sometimes 12' isn't high enough.
Extensions attach to the top pole.

- VPP4** 48" extension pole
- VPP8** 96" extension pole



- VCE3** Extra single sided clamp. Set (2)*
- VCE4** Extra double sided clamp. Set (2)*

*One for 1-3/8" & one for 1-1/2" diameter.

- S** Satin Silver **-B** Matte Black

VPP2SC-S VPP1CG-S with VCE3 -S clamp set.

PORTAPOLES

- Opens 12', closes 7'
- Beautiful satin finishes
- Moveable clamp assemblies
- Clamp range to 1/2" thick
- One Clamp for 1-3/8" & one for 1-1/2" diameter poles.



LIGHTWEIGHT & STRONG



VCST31-S

Exhibitor Products

Literature Stands

- Wire baskets hold literature up to 9" wide, leaning invitingly forward
- 1 & 2 sided models: hold either 5 or 10 baskets
- 60" total height
- Attractive black powder coated finish
- Steel 12" square base
- Footprint is only one square foot

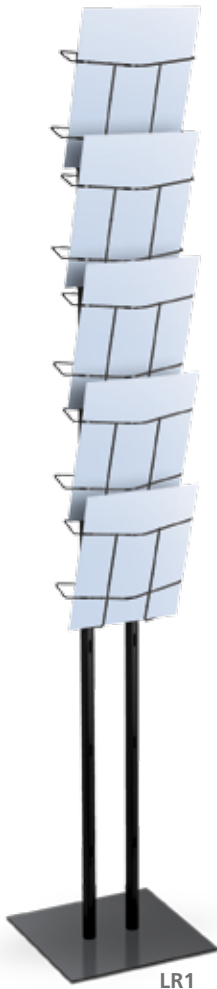

LR1



FREE bag with every stand!

Well designed nylon carry bag is included for portable use. Features a special compartment with straps to hold base securely.

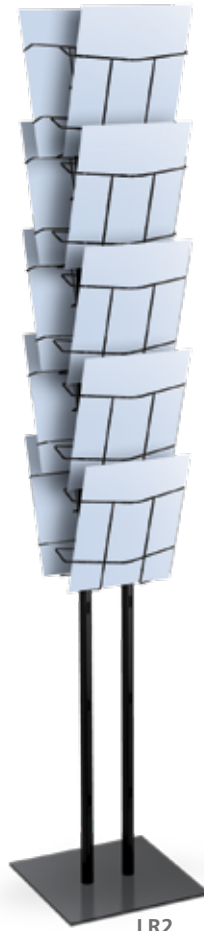

LR2

LR1	5 pocket literature stand & bag	11 lbs.
LR2	10 pocket literature stand & bag	12.5 lbs.
EBGLR	Literature stand bag ONLY	3.5 lbs.

Bag Racks

Bag Racks provide attractive advertising. We are now happy to offer telescopic models. 40" high, 24" long arms, finial top. 3 base styles and 2 finishes available. Weight: 6 lbs.

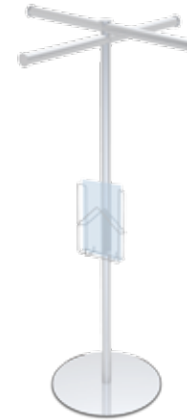

Custom models also available!



TB Travel Base



Round Base option



SBR1 with SWBWL signholder



SWBWL-S Signholder

SBR1	Silver	12" square	SBR8	Black	Travel base*
SBR2	Silver	Travel base*	SBR9	Black	11" round base
SBR3	Silver	11" round base	SWBWL	-B or -S	Wire signholder accessory
SBR7	Black	12" square base	EBGX	*Bag available for travel models	

Telescopic uprights add a -TP example: **SBR1TP** **SWBWL** Specify: -B Matte Black -S Satin Silver

Exhibitor Products

Print Racks

Easy access and storage of unframed prints, posters and paintings. Use in galleries, stores and studios. Print Racks organize space efficiently and cost-effectively.



PR38



PR42



PR63



PR64

Model	Open Size h-w	Construction
PR38	39.5"-24"	Aluminum legs, canvas bed
PR42	39.5"-32"	Aluminum legs, canvas bed
PR63	32"-34"	Welded steel, white enamel finish
PR64	32"-34"	Welded steel, black enamel finish

Projector Stand

Ideal for multi-media presentations. Perfect solution for A-V equipment

MULTIMEDIA SUPPORT

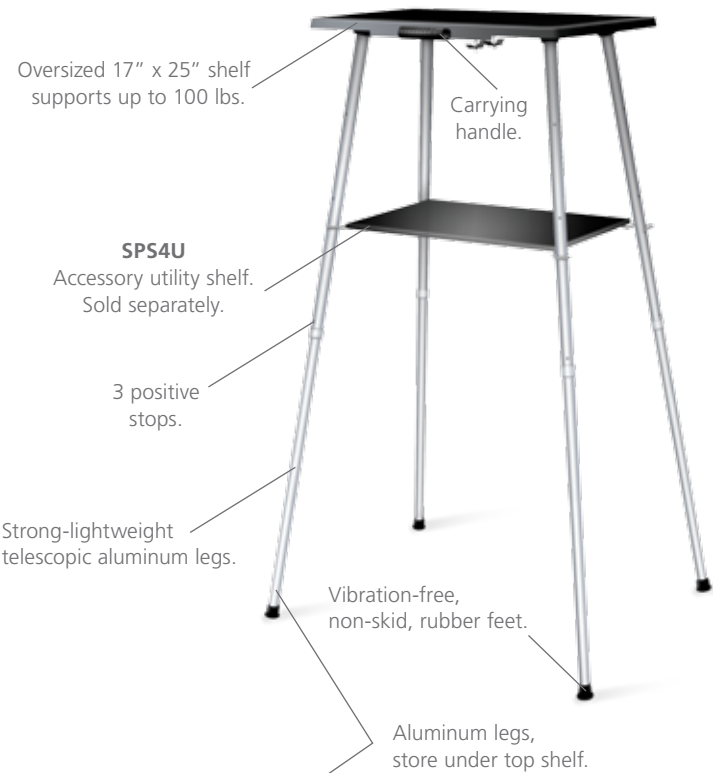

Oversized 17" x 25" shelf supports up to 100 lbs.

Carrying handle.

SPS4U
Accessory utility shelf. Sold separately.

3 positive stops.

Strong-lightweight telescopic aluminum legs.

Vibration-free, non-skid, rubber feet.

Aluminum legs, store under top shelf.

EASY TO CARRY AND SET-UP.



SPS1	Adjusts from 24" to 41"	8.5 lbs.
SPS2	Adjusts from 32" to 56"	9.5 lbs.
SPS4U	Accessory wood utility shelf	4.5 lbs.

Umbrella Stand



Drip pan included.

Wastebasket



Facility Essentials

Suited for offices, lobbies, tradeshow, and other common areas. All metal, quality construction, matte black finish.

Diameter: 10" Height: 15"

60206	Wastebasket
61206	Umbrella stand

Privacy Stands™

PRIVACY FLOOR STANDS

- Aluminum construction
- 75" tall, 2 section uprights
- Graphic clips or crossbars
- Satin anodized finish
- 5 minute assembly
- Steel weighted bases

Clips accept semi-rigid or rigid graphics from .020" to .187" thick.
Styrene is an excellent media choice, as it can be rolled for easy shipping.

ECONOMICAL - EASY ASSEMBLY!

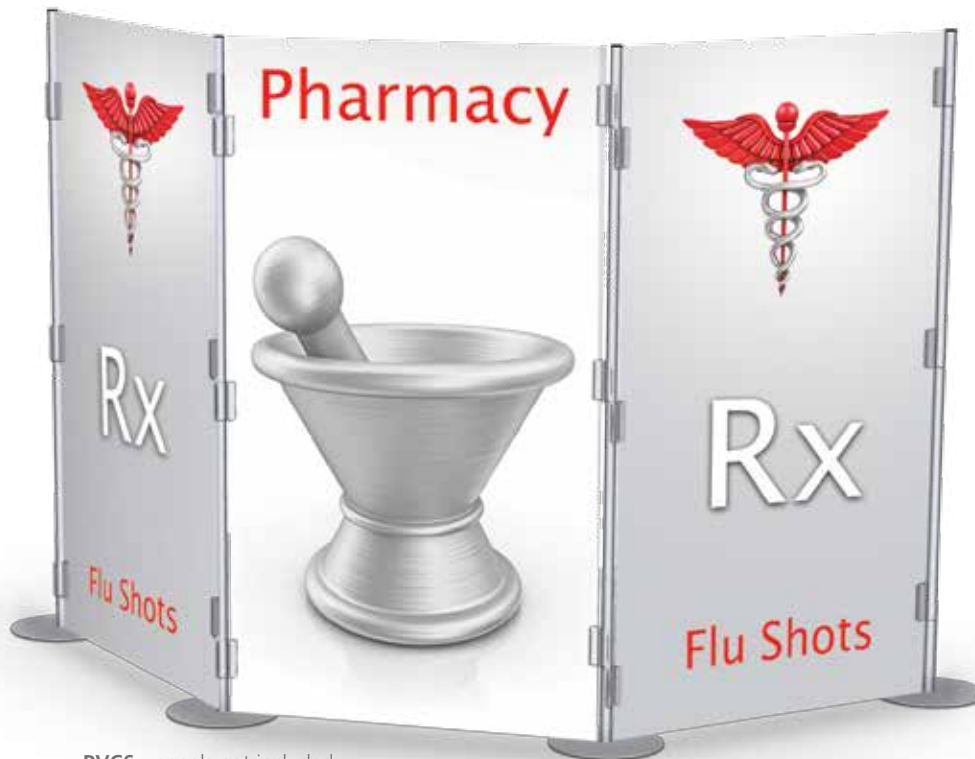

PVC6 - panels not included.



9" round laser cut steel bases.

PVC3



Units that accept 30" Pole Pocket Graphics (3/4" diameter crossbars)

PVC3	3 uprights, 3 bases, 4 crossbars holds 2 graphics
PVC3C	Same but with EBPVC case formatted for storage
PVC4	4 uprights, 4 bases, 6 crossbars holds 3 graphics
PVC4C	Same but with EBPVC case formatted for storage

Snap-on Units for Rigid & Semi-Rigid Graphics

PVC5	3 uprights, 3 bases, 12 clips holds 2 panels
PVC5C	Same but with EBPVC case formatted for storage
PVC6	4 uprights, 4 bases, 18 clips holds 3 panels
PVC6C	Same but with EBPVC case formatted for storage



EBPVC Travel Bags. Carry and store stand components together from one season to the next. Includes special base holder bar.

Table Top Exhibits

TABLETOP EXHIBITS



PVT3 Shown with Graphic panels (not included).

Model	Uprights	Clips	Holds	Model	Uprights	Clips	Holds
PVT1	4 - 24" High	12	3 panels	PVT3	4 - 36" High	12	3 panels
PVT2	5 - 24" High	16	4 panels	PVT4	5 - 36" High	16	4 panels



COH1 Telescopic Clamp-On Header Kit

- 2 Table clamps open to 2-1/2"
- 2 Telescopic clear anodized uprights
- Good for hemmed banners
- 2 Crossbars telescope from 70" to 96" good for 6' or 8' wide tables. Bottom crossbar snaps on anywhere along upright



Graphics Determine Panel Widths, Matte Silver Finish.
 Clips accepts semi-rigid or rigid graphics from .020" to .187" thick.
 Semi-rigid graphics can be rolled for easy shipping.
 .040" styrene is a perfect choice.



PVCLP
 Pack of
 12 extra clips.



Also check out our
 Tension Fabric
 Table Top Displays
 on page 99.



Convention & Hotel Easels

... ATTRACTIVE AND BUILT TO LAST.

Steel Easels

- Superior strength **Steel** construction
- Beautiful finishes
- Height: 6' • Weight: 8 lbs.
- Folds for storage 1" x 4" x 72"
- Fully-riveted, no parts to lose
- Rubber tips prevent slipping

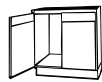

Space-saving design—
store many easels
in a small area.

Model	Description
925	Black texture
926	Brass-plated
927	Bright plated steel

Aluminum Easels

- Lightweight alloy construction
- Available in 5' or 6' models
- Aluminum, gold or black finishes
- Sign and chart holders fold flat
- Fully riveted, no parts to lose
- Outstanding choice for institutional use. Holds 50 lbs!

5' model has 3 sets
of chart holders:
6' model has 4



Model	Description	Wt. (lbs.)
900/6A	6' aluminum finish	5.0
900/6G	6' gold anodized	5.0
900/6B	6' black anodized	5.0

Model	Description	Wt. (lbs.)
900/5A	5' aluminum finish	4.5
900/5G	5' gold anodized	4.5
900/5B	5' black anodized	4.5

... PERFECT FOR HOTEL LOBBY, THEATRE OR OTHER HIGH END DISPLAYS

Baroque Easels

- Attractively plated finial ends
- Hold graphics to 2-1/2" thick & 30 lbs.
- Beautifully finished 1" diameter steel legs, 1" diameter steel legs,
- Easy assembly—durable
- Board holders 25-1/2" off floor
- Height: 5' • Weight: 7 lbs.



Lobby Easels

- Clean modern design
- Sliding adjustable signholders
- 1" diameter steel legs
- Beautiful finishes
- Built strong for rigorous use
- Height: 55" • Weight: 8 lbs.



650B Black



650 Brass (Classic)

415 Black textured

Flip Chart & Display Easels

...THE MOST POPULAR DISPLAY EASEL SERIES IN AMERICA



350, 350TZ & 555

- Hold signs, posters, boards or flipcharts (with bar)
- Metal heads, support locking braces
- 2-way adjustable board holders
- Lightweight aluminum alloy construction
- Trouble-free telescoping legs
- Reliable aluminum clutch locks
- Non-mar, non-skid rubber leg tips
- Strong riveted construction
- Height fully adjustable



Accessory Bar Converts Easel For Flipchart Use.

OUR QUALITY MAKES THE DIFFERENCE!

A presentation made with an easel and a markerboard, or an easel and flipchart, imparts a lasting impression to the audience.

...a great alternative to more costly aids and techniques.



Trouble-free clutch mechanism for secure locking.

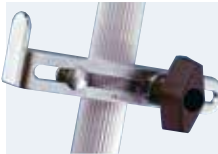

Patented metal chart holders. Height and thickness adjustable.



Legs telescope, and easel folds together for portability.



Model	Description	Color	Wt. (lbs.)
350	Display easel	Aluminum	2.3
350TZ	Flipchart easel	Aluminum	2.8
555	Jumbo easel	Aluminum	3.0
555TZ	Flipchart easel	Aluminum	3.5



EBG-X Easel bag
for any easel on this page.

Economy Display Easels

Aluminum alloy construction. Strong, lightweight, and portable.

- Lightweight Easel
- Center support, 24" shelf
- Shipped in a poly bag
- Height: 5' • Wt: 2 lbs.

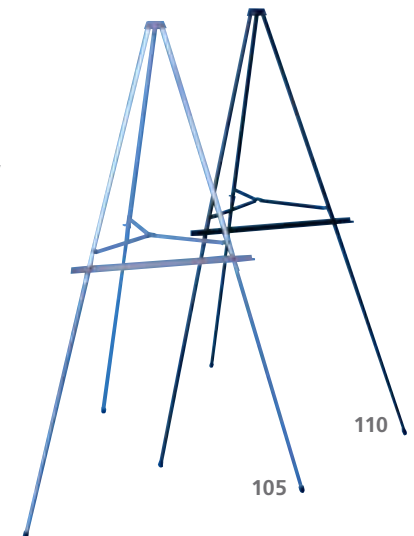

350 Series — Industry standard, utilitarian chart or display easel. Holds 30 lbs.

555 Series — Jumbo version of the 350 Series. Heavy duty, large diameter legs. Holds 50 lbs.

105 Aluminum

110 Black

PORTABLE DISPLAY AND PRESENTATION

Portable Presentation Easels

- Lightweight and durable
- Telescopic aluminum alloy legs
- Units fold to 28-1/2" x 38" x 3"
- Writing surface: 27" w x 36" h
- Metal clutch locks
- All models accept flipcharts

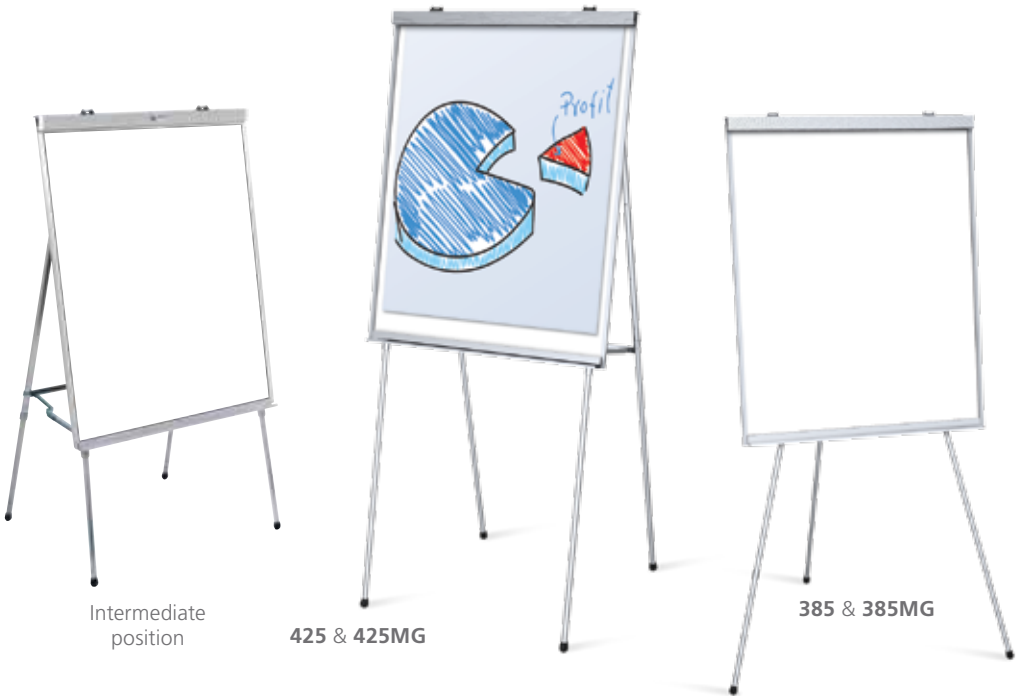

Intermediate position

425 & 425MG

385 & 385MG

425 White Markerboard
425MG White Markerboard, magnetic version

Unique, grooved 4-leg design for easy alignment into 3 positions. Full length marker/chalk tray. Spring-loaded flipchart bar for pads. Aluminum frame. Wt: 11 lbs. Wt. 17lbs. (magnetic model)

385 White Markerboard
385MG White Markerboard, magnetic version

Extremely rigid 3-leg construction. Full-length marker/chalk tray. Spring-loaded flipchart bar for pads. Aluminum frame. Wt: 10 lbs. Wt. 16lbs. (magnetic model)

Gallery & Exhibit Wall

- Ideal unit to display artwork at outdoor fairs and exhibits
- Supports and accommodates frames up to 1-1/2" deep
- Black travel bag included



GE1

Aluminum shelves have upper and lower levels.

Basic unit:

- GE1:** 68" stand, (1) 36" and (2) 52" supports, (1) 6" top support, (1) convenient carry bag.

Accessories

- GE2** 2-36" supports
- GE3** 2-52" supports
- ST12** 12" center extensions
- EBG8** Extra bag

Classic A-Frame Easels™

THE BEST MADE EASEL SERIES IN THE WORLD!

Front Plate Choices:

Aluminum: strong yet lightweight.
Steel: strong, and magnetic.

Leg Choices:

All units open to 72" high.
Folding models close to 42" high.

Common Features:

- Welded aluminum construction
- 1" square heavy duty legs
- Full 6' height
- Metal panels
- Spring-loaded pad holder
- Extremely sturdy and rigid
- Elastic strap
- Convenient tray
- Stand 6' h x 28" w x 3" d

Folding Option



Use EBG-2 Bag for folding models only.



Model	Legs	Surface	Weight (lbs.)
1520B	Black	Black steel magnetic	34
1520W	Black	White erasable steel magnetic	34
1520FB	Black folding	Black steel magnetic	36
1520FW	Black folding	White erasable steel magnetic	36

Model	Legs	Surface	Weight (lbs.)
1525B	Black	Black aluminum	27
1525W	Black	White erasable aluminum	27
1525FB	Black folding	Black aluminum	29
1525FW	Black folding	White erasable aluminum	29

HOLDS RIGID SUBSTRATES

Art Trees

Deluxe Art Tree, **ATD**, accommodates up to 32 pieces of art and includes an 11" x 17" vertical frame header. Supports are adjustable up & down the four 80" vertical uprights. 25-1/2" square welded steel base has 4 locking casters. Two-tone matte silver and black finish.

Standard Art Tree, **ATB**, displays up to 6 pieces of art, 3 on each side. Supports are adjustable up and down the 80" vertical pole. 17-1/2" x 21-1/2" steel base, 4 locking casters, handsome matte black finish.

Features:

- Designed to be portable, allowing easy adjustment
- Ideal for shows and presentations
- Great for any rigid substrate
- 4 locking casters

Model	Description	Wt. (lbs.)
ATD	Art Tree Deluxe	44
ATB	Standard Art Tree	20

FULLY ADJUSTABLE SUPPORTS

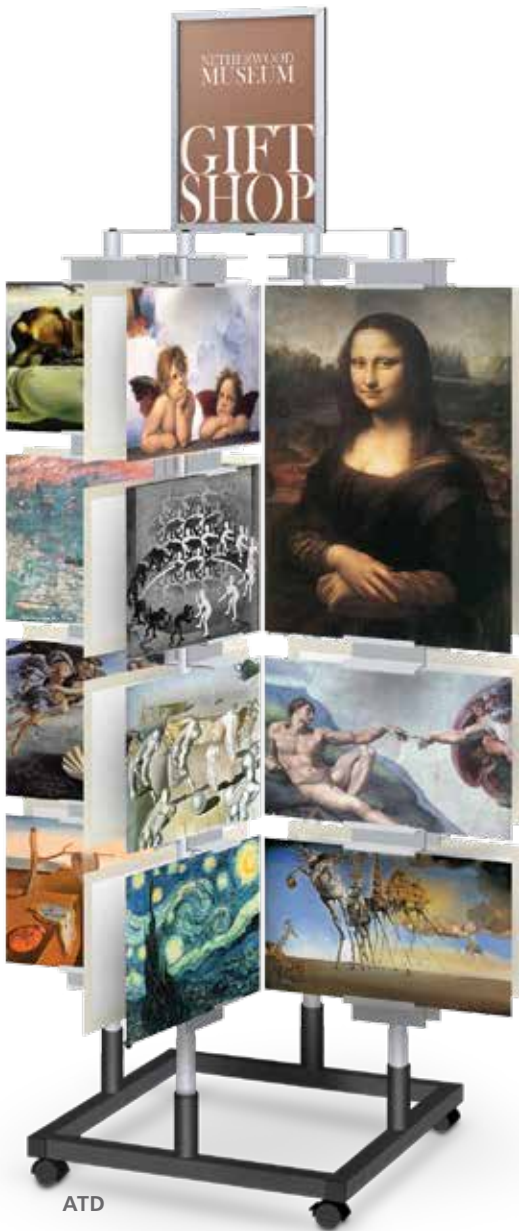

ATD



ATB

Studio Artist Easels

ALUMINUM - LIGHTWEIGHT YET STURDY!



Model	Description
500	Classic Studio Easel
600	The Studio Easel
1400	Traditional Studio Easel
1450	Superior Studio Easel



Model	Description
700	Professional Studio Easel
ST12	12" extension to center upright
ST26	26" extension to center upright



Easel Extensions
To accommodate larger canvases.

HEAVY DUTY STUDIO ARTIST EASEL - A PERFECT SOLUTION!

"High-Style" #850B

- Welded, all metal
- Double 1-1/2" dia. steel posts
- Support for wide canvases
- Good for canvases to 73" tall
- Attractive black finish
- Full canvas adjustability
- Easy to use controls
- Unit can lean forward
- 4 adjustable base glides for leveling
- Base size: 21" x 21-1/2"; tray: 21"
- Easy assembly without tools
- Adjustable back leg
- Weight: 25 lbs.
- Height: 7' open

Model	Description
850B	High style easel
850LCT	High style easel with light, casters & tray



850B Accessories

800L Easel Light—Aluminum 7" diameter reflector, 18" flexible arm with swivel. Weight: 4 lbs.

800WT Work Table—13" x 22" top slips into base of 850B Easel. Swivel & lock in place on the left or right side. Weight: 6 lbs.

8004C Caster Set—Set of 4 with locking brakes. Weight: 2 lbs.

We are very proud to offer Creo, a proven Visual Merchandising Exhibit System featuring:

- Tool-Free Assembly
Set-up designed to be intuitive, simple and fast.
- Clean Sleek Design
Award winning contemporary look.
- Easy Graphic Integration
Create brand and message awareness.
- Modular Construction
Easily reconfigured to facilitate design changes.

Creo can be customized and interpreted in an infinite number of ways. Design systems best suited to your client's requirements.

Whether for point-of-sale, trade show expositions or other mobile marketing opportunities, Creo is excellent.

Creo's value proposition is compelling.



2 minute assembly without tools!



Innovative Visual Merchandising Exhibit System



THE **DISPLAY FOLIO**[®]
Exhibit & Display Catalog

Visit www.displayfolio.com to view or download a digital copy of this catalog.